

# User's Manual

## DuraVision® FDX1501

Color LCD Monitor

## FDX1501T

Touch Panel Color LCD Monitor

### Important

Please read this User's Manual, and the Setup Manual (separate volume) carefully to familiarize yourself with safe and effective usage.

- Please refer to the Setup Manual for basic information ranging from connection of the monitor to a PC to using the monitor.
- The latest User's Manual is available for download from our web site:  
<http://www.eizo.com>



This product has been adjusted specifically for use in the region to which it was originally shipped. If operated outside this region, the product may not perform as stated in the specifications.

---

No part of this manual may be reproduced, stored in a retrieval system, or transmitted, in any form or by any means, electronic, mechanical, or otherwise, without the prior written permission of EIZO Corporation.

EIZO Corporation is under no obligation to hold any submitted material or information confidential unless prior arrangements are made pursuant to EIZO Corporation's receipt of said information.

Although every effort has been made to ensure that this manual provides up-to-date information, please note that EIZO monitor specifications are subject to change without notice.

---

# Notice for this monitor

---

Aside from creating documents, viewing multimedia content, and other general purposes, this product is also suited to the dedicated usages such as operation of terminal equipment.

---

This product has been adjusted specifically for use in the region to which it was originally shipped. If the product is used outside the region, it may not operate as specified in the specifications.

---

This product may not be covered by warranty for uses other than those described in this manual.

---

The specifications noted in this manual are only applicable when the following are used:

- Signal cables specified by us
- 

Only use optional products manufactured or specified by us with this product.

---

As it takes about 30 minutes for the performance of electrical parts to stabilize, adjust the monitor 30 minutes or more after the monitor power has been turned on.

---

Monitors should be set to a lower brightness to reduce changes in luminosity caused by long-term use and maintain a stable display.

---

When the screen image is changed after displaying the same image for extended periods of time, an afterimage may appear. Use the screen saver or power save function to avoid displaying the same image for extended periods of time.

---

Periodic cleaning is recommended to keep the monitor looking new and to prolong its operation lifetime (refer to “Cleaning” (page 4)).

---

The LCD panel is manufactured using high-precision technology. Although, missing pixels or lit pixels may appear on the LCD panel, this is not a malfunction. Percentage of effective dots: 99.9994% or higher.

---

The backlight of the LCD panel has a fixed lifetime. When the screen becomes dark or begins to flicker, please contact your local EIZO representative.

---

Do not scratch or press on the panel with any sharp objects, as this may result in damage to the panel. Do not attempt to brush with tissues as this may scratch the panel.

---

When the monitor is cold and brought into a room or the room temperature goes up quickly, dew condensation may occur on the interior and exterior surfaces of the monitor. In that case, do not turn the monitor on. Instead wait until the dew condensation disappears, otherwise it may cause some damage to the monitor.

---

(Cautions for the Use of the Touch Panel)

- During touch operation
    - Be careful of the following points. Otherwise, damage may occur to the monitor.
    - Do not strongly press, scratch, or poke the panel.
    - Do not touch the panel with hard objects such as ballpoint pens or metals.
-

## Cleaning

---

### Attention

- Chemicals such as alcohol and antiseptic solution may cause gloss variation, tarnishing, and fading of the cabinet or panel, and also quality deterioration of the image.
- Never use any thinner, benzene, wax, and abrasive cleaner, which may damage the cabinet or panel.
- Do not allow liquid to enter the clearance between the panel and the panel frame.

### Note

- The optional ScreenCleaner is recommended for cleaning the cabinet and panel surface.

If necessary, the stains on the cabinet and panel surface can be removed by moistening part of a soft cloth with water.

## To use the monitor comfortably

---

- An excessively dark or bright screen may affect your eyes. Adjust the brightness of the monitor according to the environmental conditions.
- Staring at the monitor for a long time tires your eyes. Take a 10-minute rest every hour.

# CONTENTS

<b>Cover</b> .....	<b>1</b>	<b>Chapter 4 Power Saving Functions</b> .....	<b>20</b>
Notice for this monitor .....	3	4-1. Power Saving Mode .....	20
<b>CONTENTS</b> .....	<b>5</b>	4-2. Setting Power Indicator <Power Indicator> .....	20
<b>Chapter 1 Introduction</b> .....	<b>6</b>	4-3. Enabling/Disabling Automatic Brightness Adjustment “Auto EcoView” ..	21
1-1. Features .....	6	4-4. Setting Indicator “EcoView Index” .....	21
1-2. EIZO LCD Utility Disk .....	6	4-5. Enabling/Disabling Auto Power-OFF <Off Timer> .....	21
● Disk contents and software overview .....	6	<b>Chapter 5 Troubleshooting</b> .....	<b>22</b>
● To use touch panel driver .....	6	5-1. No picture .....	22
1-3. Basic Operations and Functions .....	7	5-2. Imaging problems (for both digital and analog) .....	23
● Basic Adjustment menu operations .....	7	5-3. Imaging problems (for analog only) .....	24
● Functions .....	8	5-4. Other problems .....	24
<b>Chapter 2 Adjusting Screens</b> .....	<b>9</b>	5-5. Touch panel problems (for FDX1501T only) .....	25
2-1. Setting the Resolution .....	9	<b>Chapter 6 Reference</b> .....	<b>26</b>
● Display resolution .....	9	6-1. How to Attach the Optional Arm .....	26
● Setting resolution .....	9	6-2. Connecting Multiple PCs .....	27
Windows 7 .....	9	● To switch among input signals .....	27
Windows Vista .....	9	● To set input signal selection <Input Signal> ..	28
Windows XP .....	9	6-3. Displaying Monitor Information <Information> .....	28
Mac OS X .....	9	6-4. Specifications .....	29
2-2. Displaying Screen Correctly .....	10	6-5. Glossary .....	32
● Digital Signal Input .....	10	6-6. Preset Timing .....	34
● Analog Signal Input .....	10	<b>Appendix</b> .....	<b>35</b>
2-3. Adjusting Color .....	14	Trademark .....	35
● To select the display mode (Color Mode) .....	14	FCC Declaration of Conformity .....	36
● To perform advanced adjustments .....	14	LIMITED WARRANTY .....	37
● Adjustable settings in each mode .....	14	China Measures for RoHS Compliance in ChinaRoHS .....	46
● To adjust brightness <Brightness> .....	15		
● To adjust contrast <Contrast> .....	15		
● To adjust color temperature <Temperature> ..	16		
● To adjust gain <Gain> .....	16		
<b>Chapter 3 Setting Monitor</b> .....	<b>17</b>		
3-1. Adjusting Volume “Volume” .....	17		
3-2. Changing Adjustment Menu Display Position <Menu Position> .....	17		
3-3. Locking Buttons .....	17		
● To lock adjustments/settings in the Adjustment menu .....	17		
● To lock all operations .....	17		
3-4. Setting the EIZO Logo Display .....	18		
3-5. Setting Language <Language> .....	18		
3-6. Enabling/Disabling DDC/CI communication .....	18		
3-7. Resetting the Monitor to the Default Settings <Reset> .....	19		
● To reset the color adjustments .....	19		
● To reset all adjustments to the default settings .....	19		

# Chapter 1 Introduction

Thank you very much for choosing an EIZO color LCD monitor.

## 1-1. Features

- 15" LCD
- Applicable to the resolution of 1024 × 768.
- LED backlight LCD panel  
The LED backlight provides better power efficiency and reduced power consumption compared to existing fluorescent backlight LCD panels. No mercury, a hazardous substance, is used.
- High-intensity pane  
Maintains visibility under high-illumination conditions
- Anti-dust design allows use in a wide range of environments.  
A design without ventilation holes in the main unit makes dust penetration difficult.
- Supports a wide range of operating temperatures and operating humidity
  - Operating temperature : 0°C to 50°C (32°F to 122°F)
  - Operating humidity: 20% to 90% R.H. (wet bulb temperature ≤ 39 °C (102 °F), no condensation)
- A 3-year long-term warranty for 24-hour continuous use
  
- Resistive technology touch panel function (for FDX1501T only)  
Compatible with Microsoft Windows 7 / Vista / XP

## 1-2. EIZO LCD Utility Disk

An "EIZO LCD Utility Disk" (CD-ROM) is supplied with this product. The following table shows the disk contents and the overview of the software programs.

### ● Disk contents and software overview

The disk includes adjustment software, touch panel software, and user's manuals. Refer to Readme.txt file on the disk for software startup procedures or file access procedures.

Item	Overview	Windows	Macintosh
A "Readme.txt" file		√	√
Screen adjustment pattern files	Used when adjusting the image of analog signal input manually.	√	√
Touch Panel Driver*	Driver for touch panel	√	-
User's Manual of this monitor (PDF file)		√	√
User's Manual for Touch Panel Driver (PDF file)*		√	-

\* Used only for the FDX1501T.

### ● To use touch panel driver

For information on how to install or use the touch panel driver, see the Touch Panel Driver User's Manual (on the CD-ROM).

# 1-3. Basic Operations and Functions

## ● Basic Adjustment menu operations

### 1. Displaying Adjustment Menu

1. Press . The adjustment menu appears.

At digital signal input

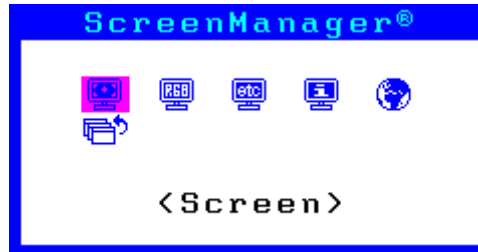

### 2. Adjusting/Setting

1. Choose a menu to adjust/set with or , and then press . The Sub menu appears.



2. Choose an item to adjust/set with or , and then press . The adjustment/ setting menu appears.

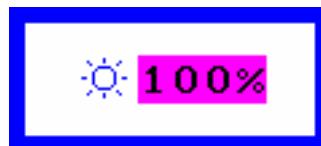

3. Adjust/set the selected item with or , and then press .

### 3. Exiting

1. Choose <Return> from the Sub menu and press . The Main menu appears.
2. Choose <Exit> from the Main menu and press . The Adjustment menu exits.

























---

#### Note

- The Adjustment menu can also be exited by pressing twice quickly.
-

## ● Functions

The following table shows all the Adjustment menu's adjustment and setting menus.

Main menu	Setting	Reference
Auto Adjustment* <sup>1</sup> 	 Screen	"2-2. Displaying Screen Correctly" (page 10)
	 Range	
Screen 	 Clock* <sup>1</sup>	
	 Phase* <sup>1</sup>	
	 Hor.Position* <sup>1</sup>	
	 Ver.Position* <sup>1</sup>	
	 Smoothing	
	 Return	
Color* <sup>2</sup> 	 Brightness	"2-3. Adjusting Color" (page 14)
	 Color Mode	
	 Contrast	
	 Temperature	
	 Gain	
	 Reset	"To reset the color adjustments" (page 19)
Others 	 Input Signal	"To set input signal selection <Input Signal>" (page 28)
	 Off Timer	"4-5. Enabling/Disabling Auto Power-OFF <Off Timer>" (page 21)
	 Menu Position	"3-2. Changing Adjustment Menu Display Position <Menu Position>" (page 17)
	 Power Indicator	"4-2. Setting Power Indicator <Power Indicator>" (page 20)
	 Reset	"To reset all adjustments to the default settings" (page 19)
Information 		"6-3. Displaying Monitor Information <Information>" (page 28)
Language 		"3-5. Setting Language <Language>" (page 18)

\*<sup>1</sup> Analog signal input only

\*<sup>2</sup> The adjustment/settings available on the <Color> menu depend on the selected Color Mode (see "Adjustable settings in each mode" (page 14)).



# Chapter 2 Adjusting Screens

## 2-1. Setting the Resolution

### ● Display resolution

For details on compatible resolutions, refer to “Compatible Resolutions” in the Setup Manual.

### ● Setting resolution

When you connect the monitor to the PC and find that the resolution is improper, or when you want to change the resolution, follow the procedure below.

#### Windows 7

1. Right-click the mouse anywhere on the desktop except for icons.
2. From the displayed menu, click “Screen resolution”.
3. On the “Screen Resolution” dialog box, select the monitor.
4. Click “Resolution” to select the desired resolution.
5. Click the “OK” button.
6. When a confirmation dialog box is displayed, click [Keep changes].

#### Windows Vista

1. Right-click the mouse anywhere on the desktop except for icons.
2. From the displayed menu, click “Personalize”.
3. On the “Personalization” window, click “Display Settings”.
4. On the “Display Settings” dialog box, select the “Monitor” tab and select desired resolution in the “Resolution” field.
5. Click the “OK” button.
6. When a confirmation dialog box is displayed, click “Yes”.

#### Windows XP

1. Right-click the mouse anywhere on the desktop except for icons.
2. From the displayed menu, click “Properties”.
3. When the “Display Properties” dialog box is displayed, click the “Settings” tab and select desired resolution for “Screen resolution” under “Display”.
4. Click the “OK” button to close the dialog box.

#### Mac OS X

1. Select “System Preferences” from the Apple menu.
2. When the “System Preferences” dialog box is displayed, click “Displays” for “Hardware”.
3. On the displayed dialog box, select the “Display” tab and select desired resolution in the “Resolutions” field.
4. Your selection will be reflected immediately. When you are satisfied with the selected resolution, close the window.

## 2-2. Displaying Screen Correctly

### ● Digital Signal Input

When digital signals are input, images are displayed correctly based on the preset data of the monitor, but if characters and/or lines appear blurred, go to “6. Modify blurred characters or lines.” (page 13).

When performing more advanced adjustment, see “2-3. Adjusting Color” (page 14) and subsequent pages.

### ● Analog Signal Input

---

**Attention**

- The monitor will take about 30 minutes before its internal electric components stabilize. Wait 30 minutes or more after turning the monitor power on before starting adjustment.
- The self adjustment function does not work for the images under the vertical resolution of 480 or less.
- The self adjustment and auto adjustment functions work correctly when an image is fully displayed over the Windows or Macintosh display area. They do not work properly in the cases below:
  - When an image is displayed only on a part of the screen (command prompt window, for example)
  - When a black background (wallpaper, etc.) is in useAlso, these functions cannot work properly in some graphic boards.

---

The monitor screen adjustment is used to suppress flickering of the screen or adjust screen position and screen size correctly according to the PC to be used.

---

**Note**

- The self adjustment function works when all of the following conditions are satisfied:
  - When a signal is input into the monitor for the first time or when a resolution or vertical/horizontal scan frequency not used before is set

---

If the screen is not displayed correctly even after performing the self adjustment operation, adjust the screen according to the procedures on the following pages to use the monitor comfortably.

## Setting Procedures

### 1. Perform the auto adjustment.

#### ● To adjust flickering, screen position, and screen size automatically <Screen>

**Procedure**

1. Choose <Auto Adjustment> from the Adjustment menu, and press **⏏**.
2. Choose <Screen> from the <Auto Adjustment> menu, and press **⏏**.  
The <Auto Adjustment> menu appears.
3. Select <Execute> with **⏏** or **⏏**, and press **⏏**.

Flickering, screen position, and screen size are corrected by the auto-adjustment function.

If the screen is not displayed correctly even after performing “1. Perform the auto adjustment.” (page 10), perform the adjustments according to the procedures on the following pages. If the screen is displayed correctly, go to “5. Adjusting color gradation.” (page 13).

## 2. Prepare to use analog screen adjustment patterns.

Load the “EIZO LCD Utility Disk” to your PC, and then open the “Screen adjustment pattern files”.

### Note

- For details and instructions on opening the “Screen adjustment pattern files”, refer to the Readme.txt file.

## 3. Perform the auto adjustment again with the analog screen adjustment pattern displayed.

### ● To adjust flickering, screen position, and screen size automatically <Screen>

#### Procedure

1. Display Pattern 1 in full screen on the monitor using the “Screen adjustment pattern files”.

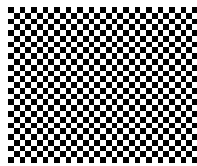

2. Choose <Auto Adjustment> from the Adjustment menu, and press .
  3. Choose <Screen> from the <Auto Adjustment> menu, and press .
- The <Auto Adjustment> menu appears.
4. Select <Execute> with  or , and press .

Flickering, screen position, and screen size are corrected by the auto-adjustment function.

If the screen is not displayed correctly even after performing “3. Perform the auto adjustment again with the analog screen adjustment pattern displayed.” (page 11), perform the adjustments according to the procedures on the following pages. If the screen is displayed correctly, go to “5. Adjusting color gradation.” (page 13).

## 4. Choose <Screen> from the Adjustment menu to perform advanced adjustments.

Adjust the clock, phase and position, in this order.

### ● To eliminate vertical bars <Clock>

#### Procedure

1. Choose <Clock> from the <Screen> menu, and press .
- The <Clock> menu appears.
2. Adjust the clock with  or  to eliminate vertical bars.
- Press  or  slowly so as not to miss the adjustment point.
3. Press  to exit the adjustment.

When blurring, flickering or bars appear on the screen after adjustment, proceed to “Phase” to remove flickering or blurring.

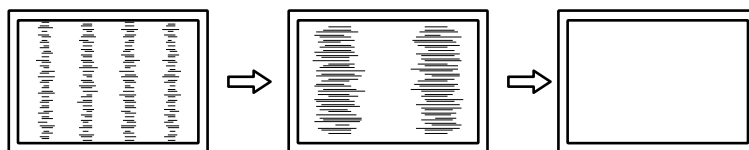

## ● To remove flickering or blurring <Phase>

### Procedure

1. Choose <Phase> from the <Screen> menu, and press .

The <Phase> menu appears.

2. Adjust the phase with  or  to minimize flickering or blurring.
3. Press  to exit the adjustment.

When vertical bars appear on the screen after adjustment, go back to “To eliminate vertical bars <Clock>”.  
(Clock → Phase → Position)

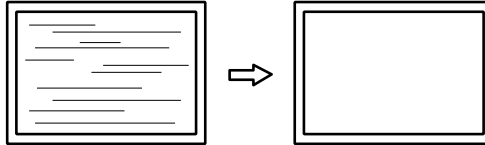

---

### Attention

- Flickering or blurring may not be eliminated depending on your PC or graphics board.
- 





## ● To correct the screen position <Hor.Position> <Ver.Position>

---

### Note

- Since the number of pixels and the pixel positions are fixed on the LCD monitor, only one position is provided to display images correctly. The position adjustment is made to shift an image to the correct position.
- 

### Procedure

1. Choose <Hor.Position> or <Ver.Position> from the <Screen> menu, and press .
- The <Hor.Position> or <Ver.Position> menu appears.
2. Adjust the position with  or .
3. Press  to exit the adjustment.

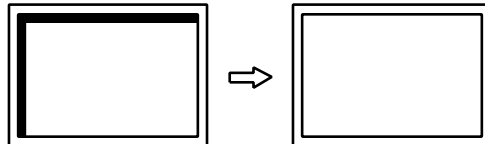

4. Close Pattern 1.

## 5. Adjusting color gradation.

### ● To adjust color gradation automatically <Range>

Every color gradation (0 to 255) can be displayed by adjusting the signal output level.

#### **Procedure**

1. Display Pattern 2 in full screen on the monitor using the “Screen adjustment pattern files”.

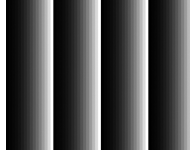

2. Choose <Auto Adjustment> from the Adjustment menu, and press .
3. Choose <Range> from the <Auto Adjustment> menu, and press .  
The <Range> menu appears.
4. Select <Execute> with  or , and press .  
The output range is set automatically.
5. Close Pattern 2.

## 6. Modify blurred characters or lines.

### ● To modify blurred characters/lines <Smoothing>

When an image is displayed with a resolution other than recommended, the characters or lines of the displayed image may blur.

---

#### **Attention**

- Smoothing setting may not be required depending on the display resolution. (You cannot choose the smoothing icon.)
- 

#### **Adjustable range**

1 to 5

#### **Procedure**

1. Choose <Screen> from the Adjustment menu, and press .
2. Choose <Smoothing> from the <Screen> menu, and press .  
The <Smoothing> menu appears.
3. Use  or  for adjustment.
4. Press  to exit the adjustment.

## 2-3. Adjusting Color





### ● To select the display mode (Color Mode)

This function allows easy selection of a desired mode according to monitor application.

#### Display Modes

Mode	Purpose
Custom	Select one of these user modes to define a desired set of parameter settings.
EyeCare	Allows the brightness to be set lower than possible with other modes.
sRGB	Suitable for color matching with sRGB compatible peripherals.
Text	Suitable for displaying texts for word processing or spreadsheets.

#### Procedure

1. Choose <Color> from the Adjustment menu, and press .
2. Choose <Color Mode> from the <Color> menu, and press .
3. Use  or  for adjustment.
4. Press  to exit the adjustment.

### ● To perform advanced adjustments

The <Color> menu of the Adjustment menu allows you to configure and save a separate set of color settings for each mode.

#### Attention

- The monitor will take about 30 minutes before its internal electric components stabilize. Wait 30 minutes or more after turning the monitor power on before starting adjustment.
- Perform the range adjustment first when adjusting color for analog signals (see “To adjust color gradation automatically <Range>” (page 13)).
- The same image may be seen in different colors on multiple monitors due to their monitor-specific characteristics. Make fine color adjustment visually when matching colors on multiple monitors.





#### Note

- The values shown in “%” or “K” are available only as reference.

### ● Adjustable settings in each mode

The adjustable settings depend on the mode. (You cannot select any non-adjustable or non-settable function.)

√: Adjustable - : Not adjustable

Icon	Function	Color Mode			
		Custom	EyeCare	sRGB	Text
	Brightness	√	√	√	√
	Contrast	√	-	-	√
	Temperature	√	√	-	√
	Gain	√	√	-	-
	Reset	√	√	√	√

## ● To adjust brightness <Brightness>

The screen brightness is adjusted by changing the brightness of the backlight (light source from the LCD back panel).

### **Adjustable range**

0 to 100%

### **Procedure**

1. Press ◀ or ▶.  
The Brightness menu appears.
2. Use ◀ or ▶ for adjustment.
3. Press ● to exit the adjustment.

---

#### **Note**

- If you feel that the image is too bright even if the brightness is set to 0% or that the image is too dark even if the brightness is set to 100%, adjust the contrast.
  - Alternatively, you can use <Brightness> under <Color> in the Adjustment menu to adjust it.
- 

## ● To adjust contrast <Contrast>

The brightness of the screen is adjusted by varying the video signal level.

### **Adjustable range**

0 to 100%

### **Procedure**

1. Choose <Color> from the Adjustment menu, and press ●.
2. Choose <Contrast> from the <Color> menu, and press ●.  
The <Contrast> menu appears.
3. Use ◀ or ▶ for adjustment.
4. Press ● to exit the adjustment.

---

#### **Note**

- In the contrast of 50%, every color gradation is displayed.
  - When adjusting the monitor, it is recommended to perform the brightness adjustment which may not lose the gradation characteristics, prior to the contrast adjustment.
  - Perform the contrast adjustment in the following cases.
    - When you feel the image is too dark even if the brightness is set to 100% (Set the contrast to higher than 50%.)
    - When you feel the image is too bright even if the brightness is set to 0% (Set the contrast to lower than 50%.)
-

## ● To adjust color temperature <Temperature>

Color temperature can be adjusted.

The color temperature is normally used to express the hue of “White” and/or “Black” by a numerical value. The value is expressed in degrees “K” (Kelvin).

The screen becomes reddish at a low color temperature, and bluish at a high color temperature, like the flame temperature. A gain preset value is set for each color temperature setting value.

### **Adjustable range**

Off, 5000K, 6500K, 9300K

### **Procedure**

1. Choose <Color> from the Adjustment menu, and press **⏏**.
2. Choose <Temperature> from the <Color> menu, and press **⏏**.  
The <Temperature> menu appears.
3. Use **⏪** or **⏩** for adjustment.
4. Press **⏏** to exit the adjustment.

---

#### **Note**

- <Gain> allows you to perform more advanced adjustment (see “To adjust gain <Gain>” (page 16)).
  - If you set to “Off”, the image is displayed in the preset color of the monitor (Gain: 100% for each RGB).
  - When gain is changed, the color temperature is changed to “Off”.
- 

## ● To adjust gain <Gain>

The brightness of each color component red, green, and blue is called “Gain”. You can change the hue of “white” by adjusting gain.

### **Adjustable range**

0 to 100%

### **Procedure**

1. Choose <Color> from the Adjustment menu, and press **⏏**.
2. Choose <Gain> from the <Color> menu, and press **⏏**.  
The <Gain> menu appears.
3. Adjust gain with **⏪** or **⏩** for each of red, green, and blue.
4. Press **⏏** to exit the adjustment.

---

#### **Attention**

- Using this function may make some color gradations unavailable for display.
- 

#### **Note**

- The value of gain changes with that of color temperature.
  - When gain is changed, the color temperature is changed to “Off”.
-



# Chapter 3 Setting Monitor





## 3-1. Adjusting Volume “Volume”

This function allows you to adjust the volume.

### **Adjustable range**

0 to 20





### **Procedure**

1. Press .  
The sound volume menu appears.
2. Use  or  for adjustment.
3. Press  to exit the adjustment.

## 3-2. Changing Adjustment Menu Display Position <Menu Position>

You can change the display position of the Adjustment menu.

### **Procedure**



1. Choose <Others> from the Adjustment menu, and press .
2. Choose <Menu Position> from the <Others> menu, and press .
- The <Menu Position> menu appears.
3. Adjust the position with  or .
4. Press  to exit the adjustment.

## 3-3. Locking Buttons

This function allows you to lock to prevent changing the adjusted/set status.



### ● To lock adjustments/settings in the Adjustment menu

#### **Procedure**

1. Press  to turn off the monitor.
2. Press  holding  down to turn on the monitor.  
You can toggle between Lock and Unlock by performing steps 1 and 2.

### ● To lock all operations

#### **Procedure**

1. Holding  down, press  for five seconds while the screen is displayed.  
You can toggle between Lock and Unlock by performing this step.

## 3-4. Setting the EIZO Logo Display

You can choose to display or not to display the EIZO logo, which appears when you turn on the monitor.

### Procedure

1. Press  $\odot$  to turn off the monitor.
2. Press  $\odot$  holding  $\bullet$  down to turn on the monitor.

The EIZO logo display setting is toggled by performing the operation in steps 1 and 2.

## 3-5. Setting Language <Language>

This function allows you to select a language for the Adjustment menu and messages.

### Selectable languages

English / German / French / Spanish / Italian / Swedish / Simplified Chinese/ Traditional Chinese/ Japanese

### Procedure

1. Choose <Language> from the Adjustment menu, and press  $\odot$ .  
The <Language> menu appears.
2. Choose a language with  $\blacktriangleleft$  or  $\blacktriangleright$ .
3. Press  $\odot$  to exit the adjustment.

## 3-6. Enabling/Disabling DDC/CI communication

This function allows you to enable/disable the DDC/CI communication (see “6-5. Glossary” (page 32)).

### Procedure

1. Press  $\odot$  to turn off the monitor.
2. Press  $\odot$  holding  $\bullet$  down to turn on the monitor.

You can toggle between Enable and Disable by performing steps 1 and 2.

---

### Note

- You can check the DDC/CI setting in the <Information> menu.
-

## 3-7. Resetting the Monitor to the Default Settings

### <Reset>

---

There are two different Resets: Color Reset for only resetting the color adjustments to the default settings and Full Reset for resetting all settings to the defaults.

---

**Attention**

- After resetting, you cannot undo the operation.

---





**Note**

- Regarding the default setting, see “[Main Default Settings](#)” (page 31).
- 

#### ● To reset the color adjustments

This function only resets the color adjustments for the currently selected mode to the default settings.

**Procedure**





1. Choose <Color> from the Adjustment menu, and press .
2. Choose <Reset> from the <Color> menu, and press .
3. Select “Reset” with  or .
4. Press .

The color adjustments revert to the default settings.

#### ● To reset all adjustments to the default settings

This function resets all adjustments to the default settings.

**Procedure**

1. Choose <Others> from the Adjustment menu, and press .
2. Choose <Reset> from the <Others> menu, and press .
3. Select “Reset” with  or .
4. Press .

All adjustments revert to the default settings.

# Chapter 4 Power Saving Functions

## 4-1. Power Saving Mode

When the monitor has shifted to the power saving mode, the images on the screen are not displayed.

### Attention

- Turning off the main power switch or unplugging the power cord completely shuts off power supply to the monitor.
- Power consumption varies even when the stereo mini jack cable is connected.

### Power Saving System

#### Analog Signal Input

This monitor complies with the VESA DPM standard.

PC		Monitor	Power Indicator
On		Operating	Blue
Power saving mode	STAND-BY SUSPENDED OFF	Power saving mode	Orange

#### Digital Signal Input

This monitor complies with the DVI DMPM standard.

The monitor enters the power saving mode in five seconds in connection with the PC setting.

PC		Monitor	Power Indicator
On		Operating	Blue
Power saving mode		Power saving mode	Orange

### Exiting the power saving mode

If the monitor receives input, it automatically exits the power saving mode and returns to the normal display mode.

## 4-2. Setting Power Indicator <Power Indicator>

This function allows you to set the power indicator (blue) ON/OFF in the monitor ON condition.

### Procedure

1. Choose <Others> from the Adjustment menu, and press **⊙**.
2. Choose <Power Indicator> from the <Others> menu, and press **⊙**.  
The <Power Indicator> menu appears.
3. Select "Enable" or "Disable" with **◀** or **▶**.
4. Press **⊙** to exit the adjustment.





## 4-3. Enabling/Disabling Automatic Brightness Adjustment “Auto EcoView”

The sensor on the front side of the monitor detects the environmental brightness to adjust the screen brightness automatically and comfortably by using the Auto EcoView function.

### Attention

- Be careful not to block the sensor on the lower side of the monitor when using the Auto EcoView function.

### Procedure

1. Press .  
The EcoView menu appears.
2. Select “On” or “Off” with  or .
3. Press  to exit the adjustment.

### Note

- For this reason, as <Brightness> in the Adjustment menu is changed, the auto adjustment range is also changed.

## 4-4. Setting Indicator “EcoView Index”

This indicator shows the power saving ratio, power reduction and CO<sub>2</sub> reduction as a result of the brightness of the monitor. The power saving ratio comes to high as the indicator level meter lights towards right.

### Procedure

1. Press .  
The EcoView menu appears.

### Note

- Power reduction: the backlight’s reduction of electricity consumption as a result of the adjusted brightness value.
- CO<sub>2</sub> reduction: converted from the “Power reduction” value, this is an estimate of the quantity of CO<sub>2</sub> emissions reduced when using the monitor for 1 hour.
- \* The numeric value is a result of a calculation based on a default value (0.000555 t -CO<sub>2</sub>/kWh) determined by a ministerial ordinance (2006, Ministry of Economy, Trade and Industry, Ministry of Environment, civil code article 3) and may differ depending on country and year.







## 4-5. Enabling/Disabling Auto Power-OFF <Off Timer>

This function allows you to specify whether to turn on/off the monitor automatically after a specified time has elapsed in the power saving mode.

### Adjustable range

Disable, Enable (0, 1, 2, 3, 5, 10, 15, 20, 25, 30, 45 min, 1-5 h)



### Procedure

1. Choose <Others> from the Adjustment menu, and press .
2. Choose <Off Timer> from the <Others> menu, and press .  
The <Off Timer> menu appears.
3. Select “Enable” or “Disable” with  or .
- If “Enable” is selected, set a monitor Off time with  or .
4. Press  to exit the adjustment.

# Chapter 5 Troubleshooting

If a problem still remains after applying the suggested remedies, contact your local dealer.



## 5-1. No picture

Problem	Possible cause and remedy
<p><b>1. No picture</b></p> <ul style="list-style-type: none"> <li>Power indicator does not light.</li> </ul> <hr/> <ul style="list-style-type: none"> <li>Power indicator is lighting blue.</li> </ul> <hr/> <ul style="list-style-type: none"> <li>Power indicator is lighting orange.</li> </ul>	<ul style="list-style-type: none"> <li>Check whether the power cord is connected properly.</li> <li>Turn off the main power, and then turn it on again a few minutes later.</li> <li>Turn the main power switch on.</li> <li>Press .</li> </ul> <hr/> <ul style="list-style-type: none"> <li>Increase &lt;Brightness&gt;, &lt;Contrast&gt;, and/or &lt;Gain&gt; in the Adjustment menu (see <a href="#">“To perform advanced adjustments” (page 14)</a>).</li> </ul> <hr/> <ul style="list-style-type: none"> <li>Switch the input signal with .</li> <li>Operate the mouse or keyboard.</li> <li>Check whether the PC is turned on.</li> </ul>
<p><b>2. The message below appears.</b></p> <ul style="list-style-type: none"> <li>This message appears when no signal is input. Example:</li> </ul> <div data-bbox="276 1034 759 1288" data-label="Image"> <p>The image shows a blue-bordered box with a white background. At the top, the text 'Signal Check' is written in yellow. Below it, the word 'Analog' is written in blue. At the bottom, the text 'No Signal' is written in red.</p> </div> <ul style="list-style-type: none"> <li>The message shows that the input signal is out of the specified frequency range. (Such signal frequency is displayed in red.) Example:</li> </ul> <div data-bbox="276 1438 759 1691" data-label="Image"> <p>The image shows a blue-bordered box with a white background. At the top, the text 'Signal Error' is written in yellow. Below it, the word 'Digital' is written in blue. Underneath, three lines of text are shown: 'fD: 94.6MHz', 'fH: 68.7kHz', and 'fV: 85.0Hz'. The values 68.7 and 85.0 are written in red.</p> </div> <p>fD: Dot Clock (Displayed only during digital signal input) fH: Horizontal Scan Frequency fV: Vertical Scan Frequency</p>	<p>This message appears when the signal is not input correctly even when the monitor functions properly.</p> <ul style="list-style-type: none"> <li>The message shown left may appear, because some PCs do not output the signal soon after power-on.</li> <li>Check whether the PC is turned on.</li> <li>Check whether the signal cable is connected properly.</li> <li>Switch the input signal with .</li> </ul> <hr/> <ul style="list-style-type: none"> <li>Check whether the PC is configured to meet the resolution and vertical scan frequency requirements of the monitor (see <a href="#">“Compatible Resolutions”</a> in the Setup Manual).</li> <li>Reboot the PC.</li> <li>Select an appropriate display mode using the graphics board's utility. Refer to the manual of the graphics board for details.</li> </ul>

## 5-2. Imaging problems (for both digital and analog)

Problem	Possible cause and remedy
1. The screen is too bright or too dark.	<ul style="list-style-type: none"><li>• Use &lt;Brightness&gt; or &lt;Contrast&gt; in the Adjustment menu to adjust it. (The LCD monitor backlight has a limited life span. When the screen becomes dark or begins to flicker, contact your local dealer.)</li><li>• Turn on the Auto EcoView function. The monitor detects the environmental brightness to adjust the screen brightness automatically.</li></ul>
2. Characters are blurred.	<ul style="list-style-type: none"><li>• Check whether the PC is configured to meet the resolution and vertical scan frequency requirements of the monitor (see “Compatible Resolutions” in the Setup Manual).</li><li>• Use &lt;Smoothing&gt; in the Adjustment menu to adjust it (see “To modify blurred characters/lines &lt;Smoothing&gt;” (page 13)).</li></ul>
3. Afterimages appear.	<ul style="list-style-type: none"><li>• Afterimages are particular to LCD monitors. Avoid displaying the same image for a long time.</li><li>• Use the screen saver or power save function to avoid displaying the same image for extended periods of time.</li></ul>
4. Green/red/blue/white dots or defective dots remain on the screen.	<ul style="list-style-type: none"><li>• This is due to LCD panel characteristics and is not a failure.</li></ul>
5. Interference patterns or pressure marks remain on the screen.	<ul style="list-style-type: none"><li>• Leave the monitor with a white or black screen. The symptom may disappear.</li></ul>
6. Noise appears on the screen.	<ul style="list-style-type: none"><li>• When entering the signals of HDCP system, the normal images may not be displayed immediately.</li></ul>
7. The screen is whitish or blackish.	<ul style="list-style-type: none"><li>• Use &lt;Contrast&gt; in the Adjustment menu to adjust it (see “To adjust contrast &lt;Contrast&gt;” (page 15)).</li></ul>

## 5-3. Imaging problems (for analog only)

Problem	Possible cause and remedy
<p>1. Display position is incorrect.</p> 	<ul style="list-style-type: none"> <li>• Use &lt;Position&gt; in the Adjustment menu to correct the image position (see “<a href="#">To correct the screen position &lt;Hor.Position&gt; &lt;Ver.Position&gt;</a>” (page 12)).</li> <li>• If the problem persists, use the graphics board’s utility if available to change the display position.</li> </ul>
<p>2. Vertical bars appear on the screen or a part of the image is flickering.</p> 	<ul style="list-style-type: none"> <li>• Use &lt;Clock&gt; in the Adjustment menu to adjust it (see “<a href="#">To eliminate vertical bars &lt;Clock&gt;</a>” (page 11)).</li> </ul>
<p>3. Whole screen is flickering or blurring.</p> 	<ul style="list-style-type: none"> <li>• Use &lt;Phase &gt; in the Adjustment menu to adjust it (see “<a href="#">To remove flickering or blurring &lt;Phase&gt;</a>” (page 12)).</li> </ul>

## 5-4. Other problems

Problem	Possible cause and remedy
1. The adjustment menu does not appear.	<ul style="list-style-type: none"> <li>• Check whether the operation lock function works (see “<a href="#">3-3. Locking Buttons</a>” (page 17)).</li> </ul>
2. All control buttons are disabled.	<ul style="list-style-type: none"> <li>• Check whether the operation lock function works (see “<a href="#">3-3. Locking Buttons</a>” (page 17)).</li> </ul>
3. The auto adjustment function does not work.	<ul style="list-style-type: none"> <li>• This function does not work during digital signal input.</li> <li>• This function is intended for use on the Macintosh and on AT-compatible PC running Windows. It does not work properly when an image is displayed only on a part of the screen (command prompt window, for example) or when a black background (wallpaper, etc.) is in use.</li> <li>• This function does not work correctly with some graphics boards.</li> </ul>
4. No audio output.	<ul style="list-style-type: none"> <li>• Check whether the stereo mini jack cable is connected properly.</li> <li>• Check whether volume is set to 0.</li> <li>• Check the PC and audio playback software to see whether they are configured correctly.</li> </ul>



## 5-5. Touch panel problems (for FDX1501T only)

### Attention

- For information on how to install or use the touch panel driver, see the Touch Panel Driver User's Manual (on the CD-ROM).

Problem	Possible cause and remedy
1. <b>Cursor position is not correct. / Cursor jumps.</b>	<ul style="list-style-type: none"><li>• Turn off and on the monitor. If the symptom is not improved, perform the calibration on the monitor.</li><li>• Touch with one finger only.</li><li>• Connect the monitor to the PC with the cable indicated in the Setup Manual or User's Manual of the monitor. Using a conversion adapter, the touch panel may not operate properly.</li></ul>
2. <b>Touch operation is not effective.</b>	<ul style="list-style-type: none"><li>• Check whether "Use EEPROM" in the "Device" menu is not checked in the "Properties" settings of the touch panel driver. If the check is already applied, perform the calibration.</li><li>• Other login user may have changed the setting. Set the touch panel driver again.</li><li>• Restart "DMC Touch Panel Configuration", or reboot the PC.</li></ul>
3. <b>Some deflection may appear on the surface of touch panel portion.</b>	<ul style="list-style-type: none"><li>• Due to the touch panel structural characteristics, the deflection may occur on the touch panel surface in high temperature/high humidity operating environment. This is not a trouble.</li></ul>
4. <b>Not touch-sound.</b>	<ul style="list-style-type: none"><li>• The touch-sound may not be output from the external line out of the PC depending on the hardware configuration.</li><li>• Under Windows 7, touch-sound is only output through the audio output terminal of the PC. To hear touch-sound, connect speakers.</li></ul>

# Chapter 6 Reference

## 6-1. How to Attach the Optional Arm

An optional arm (or an optional stand) can be attached by removing the stand section. Please refer to our web site for the corresponding optional arm (or optional stand). <http://www.eizo.com>

### Attention

- When attaching an arm or stand, follow the instructions of their user's manual.
- When using another manufacturer's arm or stand, confirm the following in advance and select one conforming to the VESA standard. Use the screws securing the unit and the stand.
  - Clearance between the screw holes: 75 mm × 75 mm or 100 mm × 100 mm
  - Thickness of plate: 2.6 mm
  - Strong enough to support weight of the monitor unit (except the stand) and attachments such as cables.
- When using an arm or stand, attach it to meet the following tilt angles of the monitor.
  - Up horizontal, down horizontal
- Do not turn the monitor in the vertical direction.
- Connect the cables after attaching an arm or stand.
- The monitor and arm or stand are heavy. Dropping them may result in injury or equipment damage.

### Procedure

**1. Lay the LCD monitor on a soft cloth spread over on a stable surface with the panel surface facing down.**

**2. Remove the stand.**

Prepare a screwdriver. Loosen the screws (four) securing the unit and the stand with the screwdriver.

**3. Attach the arm or stand to the monitor.**

Secure the monitor to the arm or stand using the screws specified in the user's manual of the arm or stand.

- Clearance between the screw holes when attach an arm or stand: In case of 75 mm × 75 mm
- Clearance between the screw holes when attach an arm or stand: In case of 100 mm × 100 mm

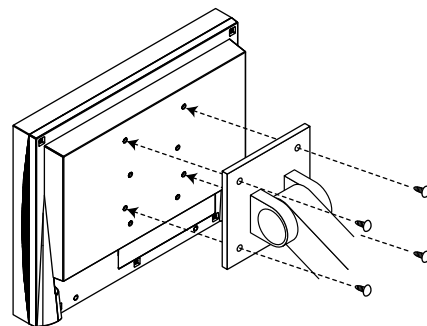
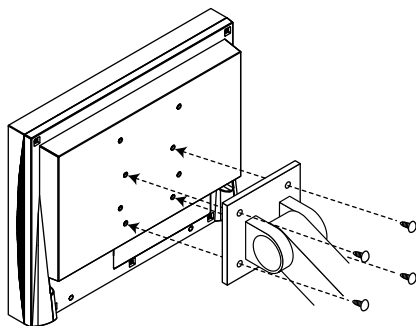

## 6-2. Connecting Multiple PCs

The product has multiple connections to PCs and allows you to switch to one of the connections for display.

### Attention

- Do not use dual link cables.
- It is assumed the touch panel monitor will be used with one computer. When the monitor is to be connected to multiple computers, connect a USB cable (MD-C93) to the computer used for touch operation (one unit only).

### Connection examples

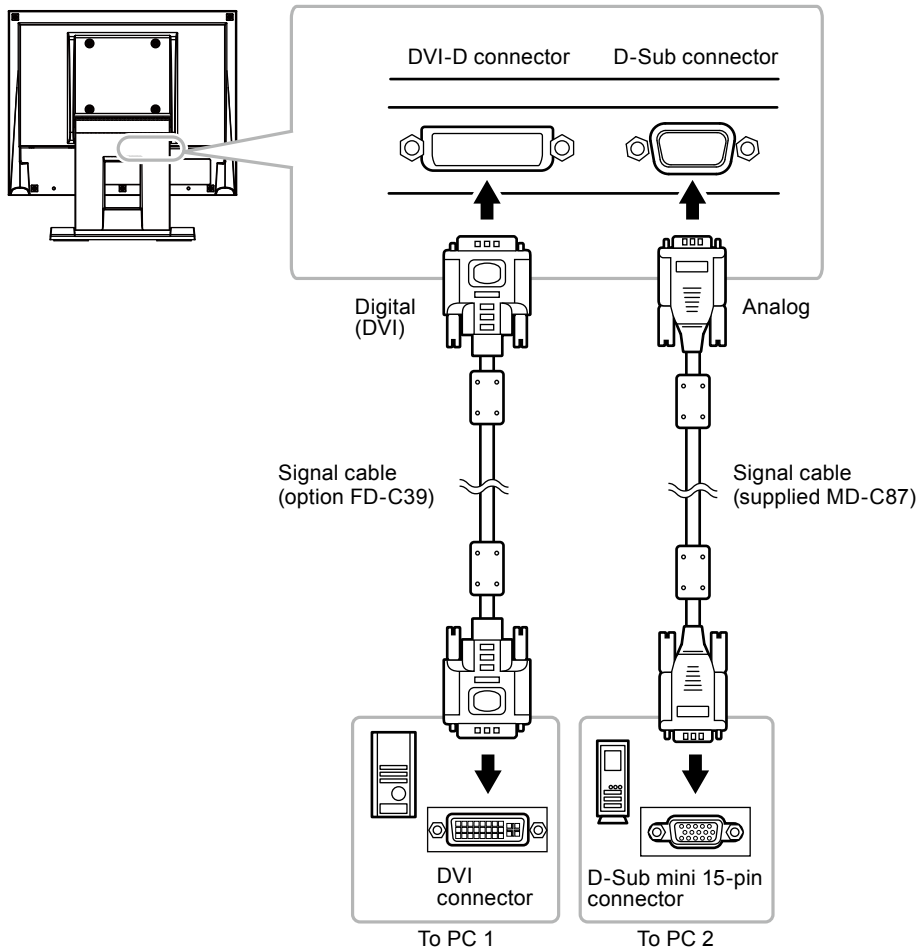

### ● To switch among input signals

The input signal switches each time  is pressed.

When the signal is switched, the active input port name appears at the top right corner of the screen.

When the signal is switched, the active signal type (Analog or Digital) appears at the top right corner of the screen for three seconds.

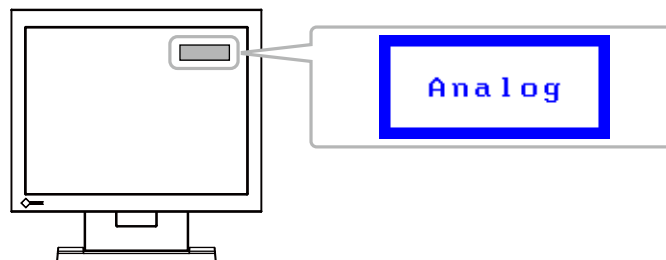

## ● To set input signal selection <Input Signal>

Setting	Function
Auto	The monitor recognizes the connector through which PC signals are input. When a PC is turned off or enters the powersaving mode, the monitor automatically displays another signal.
Manual	The monitor detects only the PC's signals currently displaying automatically. Select an active input signal with Ⓢ.

### Note

- When “Auto” is selected for <Input Signal>, the monitor’s power-saving function works only when the two PCs are in the power-saving mode.

### Procedure

1. Choose <Others> from the Adjustment menu, and press Ⓐ.
2. Choose <Input Signal> from the <Others> menu, and press Ⓐ.  
The <Input Signal> menu appears.
3. Select “Auto” or “Manual” with ⏪ or ⏩.
4. Press Ⓐ to exit the adjustment.

## 6-3. Displaying Monitor Information <Information>

This function allows you to display the input signal status, current resolution and model name.

Information 1/3: Input signal status, resolution, and horizontal/vertical scan frequencies

Information 2/3: DDC/CI Enable/Disable status

Information 3/3: Model name, serial number, and usage time

### Procedure

1. Choose <Information> from the Adjustment menu, and press Ⓐ.  
The <Information> menu appears.
2. Then, press Ⓐ to check settings, etc.

### Attention

- The usage time is not always “0” when you purchase the monitor due to factory inspection.

## 6-4. Specifications

### FDX1501

LCD panel	Size	15.0-inch (380 mm) TFT color LCD
	Surface treatment	Anti-glare, hard coating
	Surface hardness	3H
	Viewing angles	Viewing angles: Horizontal 160°, vertical 140° (CR≥10)
	Dot pitch	0.297 mm
	Response time	Black-white-black: Approx. 8 ms
Horizontal scan frequency	Analog	24.8-60.1 kHz
	Digital	31-49 kHz
Vertical scan frequency	Analog	55.0-75.1 Hz (non-interlace)
	Digital	59-61 Hz (non-interlace) (VGA TEXT: 69-71 Hz)
Resolution		1024 dots × 768 lines
Max. dot clock	Analog	80 MHz
	Digital	65 MHz
Max. display color		Approx. 16.2 million colors
Display area (H × V)		304.1 mm × 228.0 mm (12 inch × 9 inch)
Power supply		100-120 VAC ±10%, 50/60 Hz 0.33 A 200-240 VAC ±10%, 50/60 Hz 0.21 A
Power consumption	Screen display On	19 W or less
	Power saving mode	1 W or less (for D-Sub single signal input, when stereo mini jack cable is not connected)
	Power Off	1 W or less
	Main power Off	0 W
Input signal connector		D-Sub mini 15-pin
		DVI-D connector (Applicable to HDCP)
Analog input signal (Sync)		Separate, TTL, positive/negative
Analog input signal (Video)		Analog, positive (0.7Vp-p/75Ω)
Digital signal transmission		TMDS (single link)
Audio output		Speaker output: 0.5 W + 0.5 W (8Ω, THD+N: 10% or less)
Line input		Input impedance: 39 kΩ (Typ.) Input level: 2.0 Vrms (Max.)
Plug & play		VESA DDC 2B/EDID structure 1.3
Dimensions (width) × (height) × (depth)	Main unit	346 mm (13.6 inch) × 349 mm (13.7 inch) × 157 mm (6.2 inch)
	Main unit (without stand)	346 mm (13.6 inch) × 280 mm (11.0 inch) × 69 mm (2.72 inch)
Mass	Main unit	Approx. 5.7 kg (12.6 lbs.)
	Main unit (without stand)	Approx. 3.3 kg (7.3 lbs.)
Movable range		Tilt: 30° Up, 0° Down
Environmental conditions	Temperature	Operating: 0°C to 50°C (32°F to 122°F) Storage: -20°C to 60°C (-4°F to 140°F)
	Humidity	Operating: 20% to 90% R.H. (wet bulb temperature ≤ 39 °C (102 °F), no condensation) Storage: 10% to 90% R.H. (wet bulb temperature ≤ 39 °C (102 °F), no condensation)
	Air pressure	Operating: 700 to 1,060 hPa Storage: 200 to 1,060 hPa

## FDX1501T

LCD panel	Size	15.0-inch (380 mm) TFT color LCD
	Viewing angles	Viewing angles: Horizontal 160°, vertical 140° (CR≥10)
	Dot pitch	0.297 mm
	Response time	Black-white-black: Approx. 8 ms
Horizontal scan frequency	Analog	24.8-60.1 kHz
	Digital	31-49 kHz
Vertical scan frequency	Analog	55.0-75.1 Hz (non-interlace)
	Digital	59-61 Hz (non-interlace) (VGA TEXT: 69-71 Hz)
Resolution		1024 dots × 768 lines
Max. dot clock	Analog	80 MHz
	Digital	65 MHz
Max. display color		Approx. 16.2 million colors
Display area (H × V)		304.1 mm × 228.0 mm (12 inch × 9 inch)
Touch panel	Surface treatment	Anti-glare, hard coating
	Surface hardness	2H
	Communication	USB-based
	Detection method	Analog resistive technology
	OS	Microsoft Windows 7 Service Pack 1 (32 bit/64bit) Microsoft Windows Vista Service Pack 2 (32 bit) Microsoft Windows XP Service Pack 3 (32 bit) (Not compatible with Mac OS)
Power supply		100-120 VAC ±10%, 50/60 Hz 0.33 A 200-240 VAC ±10%, 50/60 Hz 0.21 A
Power consumption	Screen display On	19 W or less
	Power saving mode	1 W or less (for D-Sub single signal input, when stereo mini jack cable is not connected)
	Power Off	1 W or less
	Main power Off	0 W
Input signal connector		D-Sub mini 15-pin DVI-D connector (Applicable to HDCP)
Analog input signal (Sync)		Separate, TTL, positive/negative
Analog input signal (Video)		Analog, positive (0.7Vp-p/75Ω)
Digital signal transmission		TMD5 (single link)
Audio output		Speaker output: 0.5 W + 0.5 W (8Ω, THD+N: 10% or less)
Line input		Input impedance: 39 kΩ (Typ.) Input level: 2.0 Vrms (Max.)
Plug & play		VESA DDC 2B/EDID structure 1.3
Dimensions (width) × (height) × (depth)	Main unit	346 mm (13.6 inch) × 349 mm (13.7 inch) × 157 mm (6.2 inch)
	Main unit (without stand)	346 mm (13.6 inch) × 280 mm (11.0 inch) × 69 mm (2.72 inch)
Mass	Main unit	Approx. 6.1 kg (13.4 lbs.)
	Main unit (without stand)	Approx. 3.7 kg (8.2 lbs.)
Movable range		Tilt: 30° Up, 0° Down
Environmental conditions	Temperature	Operating: 0°C to 50°C (32°F to 122°F) Storage: -20°C to 60°C (-4°F to 140°F)
	Humidity	Operating: 20% to 90% R.H. (wet bulb temperature ≤ 39 °C (102 °F), no condensation) Storage: 10% to 90% R.H. (wet bulb temperature ≤ 39 °C (102 °F), no condensation)
	Air pressure	Operating: 700 to 1,060 hPa Storage: 200 to 1,060 hPa

## Main Default Settings

Auto EcoView	On
Smoothing	3
Color Mode	Custom
Input Signal	Auto
Off Timer	Disable
Language	English

## Outside Dimensions

- FDX1501

Unit: mm (inch)

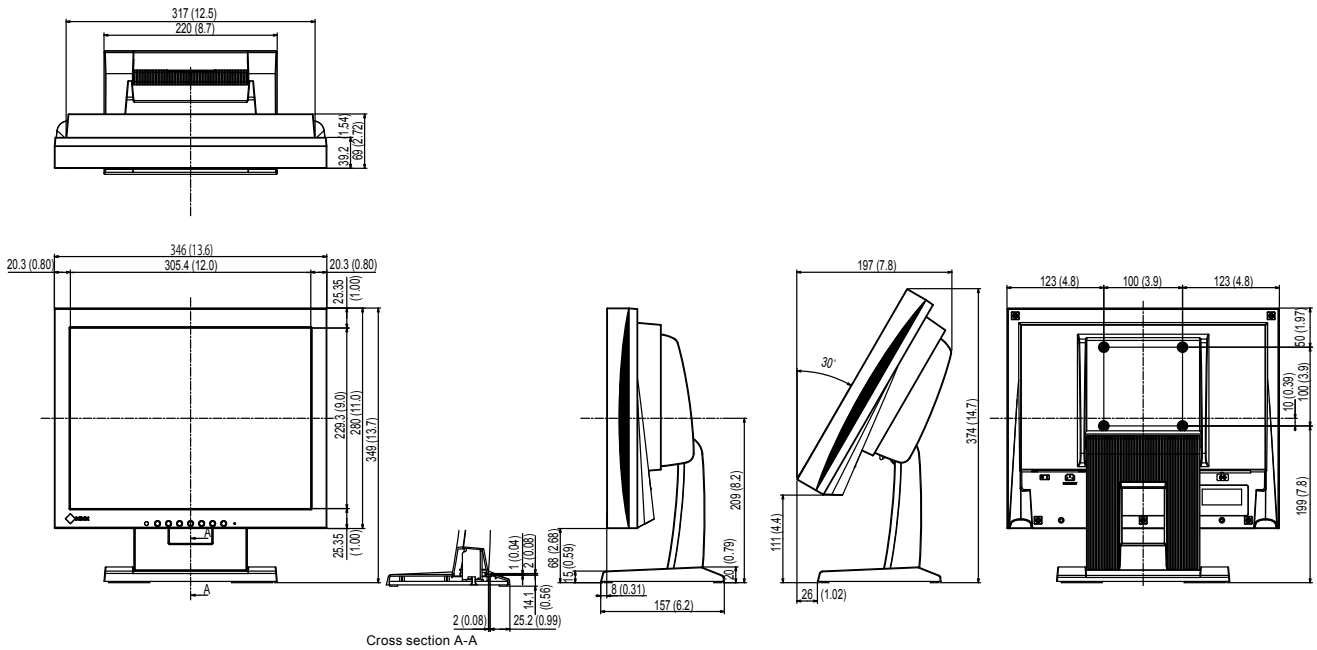

- FDX1501T

Unit: mm (inch)

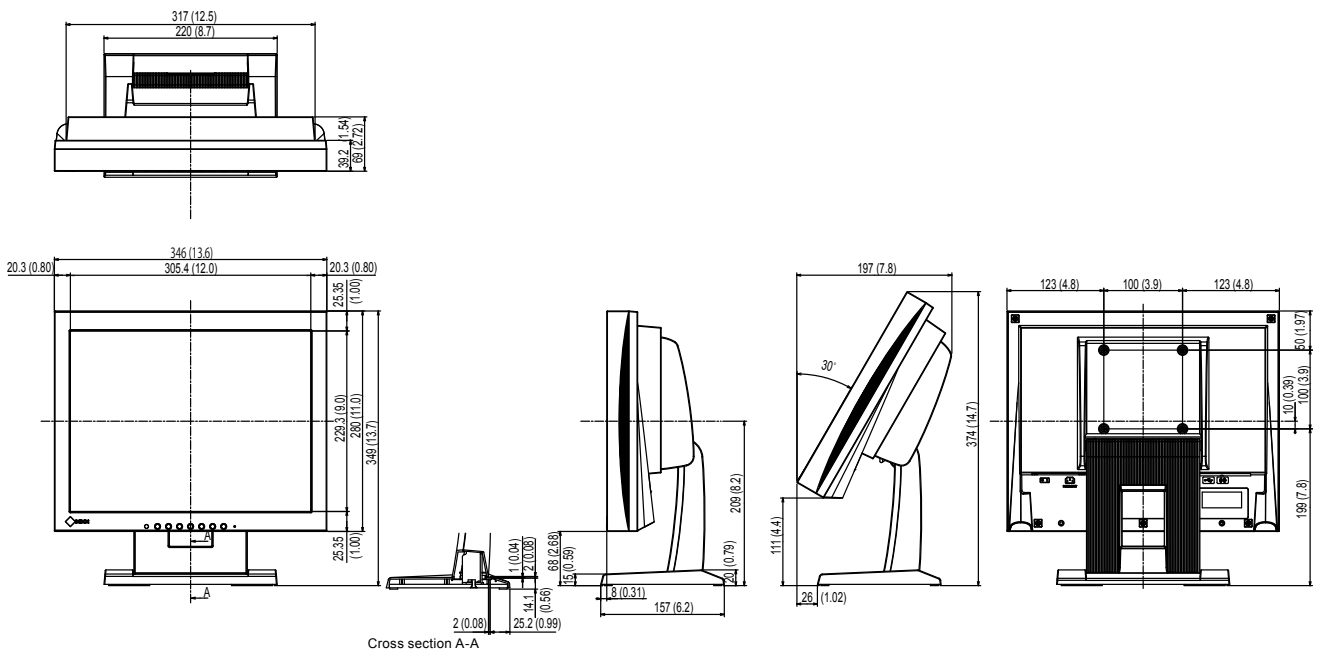

## 6-5. Glossary

---

### **Clock**

The analog signal input monitor needs to reproduce a clock of the same frequency as the dot clock of the graphics system in use, when the analog signal is converted to a digital signal for image display. This is called clock adjustment. If the clock pulse is not set correctly, some vertical bars appear on the screen.

### **DDC/CI (Display Data Channel/Command Interface)**

VESA provides the standardization for the interactive communication of the setting information, etc. between a PC and the monitor.

### **DVI (Digital Visual Interface)**

DVI is a digital interface standard. DVI allows direct transmission of the PC's digital data without loss. This adopts the TMDS transmission system and DVI connectors. There are two types of DVI connectors. One is a DVI-D connector for digital signal input only. The other is a DVI-I connector for both digital and analog signal inputs.

### **DVI DMPM (DVI Digital Monitor Power Management)**

DVI DMPM is a digital interface power-saving function. The "Monitor ON (operating mode)" and "Active Off (power-saving mode)" are indispensable for DVI DMPM as the monitor's power mode.

### **Gain**

This is used to adjust each color parameter for red, green and blue. An LCD monitor displays the color by the light passing through the panel color filter. Red, green and blue are the three primary colors. All the colors on the screen are displayed by combining these three colors. The color tone can be changed by adjusting the light intensity (volume) passing through each color's filter.

### **HDCP (High-bandwidth Digital Content Protection)**

Digital signal coding system developed to copy-protect the digital contents, such as video, music, etc. This helps to transmit the digital contents safely by coding the digital contents sent via the DVI or HDMI connector on the output side and decoding them on the input side. Any digital contents cannot be reproduced if both of the equipments on the output and input sides are not applicable to HDCP system.

### **Phase**

Phase means the sampling timing to convert the analog input signal to a digital signal. Phase adjustment is made to adjust the timing. It is recommended that phase adjustment be made after the clock is adjusted correctly.

### **Range Adjustment**

Range adjustment controls the signal output levels to display every color gradation. It is recommended that range adjustment be made before color adjustment.



## Resolution

The LCD panel consists of numerous pixels of specified size, which are illuminated to form images. This monitor consists of 1024 horizontal pixels and 768 vertical pixels. At a resolution of  $1024 \times 768$ , all pixels are illuminated as a full screen (1:1).

## sRGB (Standard RGB)

International standard for color reproduction and color space among peripheral devices (such as monitors, printers, digital cameras, scanners). As a form of simple color matching for the Internet, colors can be displayed using tones close to those of the transmission and reception devices.

## Temperature

Color temperature is a method to measure the white color tone, generally indicated in degrees Kelvin. The screen becomes reddish at a low temperature, and bluish at a high temperature, like the flame temperature.

5000K: Slightly reddish white

6500K: White referred to as daylight-balanced color

9300K: Slightly bluish white

## TMDS (Transition Minimized Differential Signaling)

TMDS is one of the signal transmission methods for the digital interface.

## VESA DPM (Video Electronics Standards Association - Display Power Management)

VESA specifications achieve increased energy efficiency for computer monitors. This involves standardization of signals sent from the computer (graphics board).

DPM defines the status of signals transmitted between the computer and monitor.

## 6-6. Preset Timing

The following table shows factory preset analog signal timing:

**Attention**

- Display position may be deviated depending on the PC connected, which may require screen adjustment using Adjustment menu.
- If a signal other than those listed in the table is input, adjust the screen using the Adjustment menu. However, screen display may still be incorrect even after the adjustment.
- When interlace signals are used, the screen cannot be displayed correctly even after screen adjustment using the Adjustment menu.

Resolution	Applicable Signals	Frequency		
		Dot Clock: MHz	Horizontal: kHz	Vertical: Hz
640 × 400	PC-9801	21.05	24.83	56.42
640 × 400	PC-9821 AP2	25.18	31.48	70.10
640 × 480	VGA	25.18	31.47	59.94
640 × 480	VESA	31.50	37.86	72.81
640 × 480	VESA	31.50	37.50	75.00
720 × 400	VGA TEXT	28.32	31.47	70.09
800 × 600	VESA	36.00	35.16	56.25
800 × 600	VESA	40.00	37.88	60.32
800 × 600	VESA	50.00	48.08	72.19
800 × 600	VESA	49.50	46.88	75.00
1024 × 768	VESA	65.00	48.36	60.00
1024 × 768	VESA	75.00	56.48	70.07
1024 × 768	VESA	78.75	60.02	75.03

# Appendix

## Trademark

The terms HDMI and HDMI High-Definition Multimedia Interface, and the HDMI Logo are trademarks or registered trademarks of HDMI Licensing, LLC in the United States and other countries.

VESA is a registered trademark of Video Electronics Standards Association.

Acrobat, Adobe, Adobe AIR, and Photoshop are registered trademarks of Adobe Systems Incorporated in the United States and other countries.

AMD Athlon and AMD Opteron are trademarks of Advanced Micro Devices, Inc.

Apple, ColorSync, eMac, iBook, iMac, iPad, Mac, MacBook, Macintosh, Mac OS, PowerBook, and QuickTime are registered trademarks of Apple Inc.

ColorMunki, Eye-One, and X-Rite are registered trademarks or trademarks of X-Rite Incorporated in the United States and/or other countries.

ColorVision and ColorVision Spyder2 are registered trademarks of DataColor Holding AG in the United States. Spyder3 and Spyder4 are trademarks of DataColor Holding AG.

ENERGY STAR is a registered trademark of the United States Environmental Protection Agency in the United States and other countries.

GRACoL and IDEAlliance are registered trademarks of International Digital Enterprise Alliance.

NEC is a registered trademark of NEC Corporation.

PC-9801 and PC-9821 are trademarks of NEC Corporation.

NextWindow is a registered trademark of NextWindow Ltd.

Pentium is a registered trademark of Intel Corporation in the United States and other countries.

PowerPC is a registered trademark of International Business Machines Corporation.

PlayStation is a registered trademark of Sony Computer Entertainment Inc.

PSP and PS3 are trademarks of Sony Computer Entertainment Inc.

RealPlayer is a registered trademark of RealNetworks, Inc.

TouchWare is a trademark of 3M Touch Systems, Inc.

Windows, Windows Media, Windows Vista, SQL Server, and Xbox 360 are registered trademarks of Microsoft Corporation in the United States and other countries.

EIZO, the EIZO Logo, ColorEdge, DuraVision, FlexScan, FORIS, RadiCS, RadiForce, RadiNET, Raptor, and ScreenManager are registered trademarks of EIZO Corporation in Japan and other countries.

ColorNavigator, EcoView NET, EIZO EasyPIX, EIZO ScreenSlicer, i•Sound, Screen Administrator, and UniColor Pro are trademarks of EIZO Corporation.

All other company and product names are trademarks or registered trademarks of their respective owners.

# FCC Declaration of Conformity

For U.S.A. , Canada, etc. (rated 100-120 Vac) Only

## FCC Declaration of Conformity

**We, the Responsible Party**

EIZO Inc.

5710 Warland Drive, Cypress, CA 90630

Phone: (562) 431-5011

**declare that the product**

Trade name: EIZO

Model: FDX1501/FDX1501T

**is in conformity with Part 15 of the FCC Rules. Operation of this product is subject to the following two conditions: (1) this device may not cause harmful interference, and (2) this device must accept any interference received, including interference that may cause undesired operation.**

This equipment has been tested and found to comply with the limits for a Class B digital device, pursuant to Part 15 of the FCC Rules. These limits are designed to provide reasonable protection against harmful interference in a residential installation. This equipment generates, uses, and can radiate radio frequency energy and, if not installed and used in accordance with the instructions, may cause harmful interference to radio communications. However, there is no guarantee that interference will not occur in a particular installation. If this equipment does cause harmful interference to radio or television reception, which can be determined by turning the equipment off and on, the user is encouraged to try to correct the interference by one or more of the following measures.

- \* Reorient or relocate the receiving antenna.
- \* Increase the separation between the equipment and receiver.
- \* Connect the equipment into an outlet on a circuit different from that to which the receiver is connected.
- \* Consult the dealer or an experienced radio/TV technician for help.

Changes or modifications not expressly approved by the party responsible for compliance could void the user's authority to operate the equipment.

### Note

Use the attached specified cable below or EIZO signal cable with this monitor so as to keep interference within the limits of a Class B digital device.

- Shielded Signal Cable (Enclosed)

## Canadian Notice

This Class B digital apparatus complies with Canadian ICES-003.

Cet appareil numérique de la classe B est conforme à la norme NMB-003 du Canada.

# LIMITED WARRANTY

---

## LIMITED WARRANTY

EIZO Corporation (hereinafter referred to as “EIZO”) and distributors authorized by EIZO (hereinafter referred to as the “Distributors”) warrant, subject to and in accordance with the terms of this limited warranty (hereinafter referred to as the “Warranty”), to the original purchaser (hereinafter referred to as the “Original Purchaser”) who purchased the product specified in this document (hereinafter referred to as the “Product”) from EIZO or Distributors, that EIZO and Distributors shall, at their sole discretion, either repair or replace the Product at no charge if the Original Purchaser becomes aware within the Warranty Period (defined below) that the Product malfunctions or is damaged in the course of normal use of the Product in accordance with the description in the instruction manual attached to the Product (hereinafter referred to as the “User’s Manual”).

The period of this Warranty is three (3) years from the date of purchase of the Product (hereinafter referred to as the “Warranty Period”). EIZO and Distributors shall bear no liability or obligation with regard to the Product in relation to the Original Purchaser or any third parties other than as provided under this Warranty.

EIZO and Distributors will cease to hold or store any parts of the Product upon expiration of seven (7) years after the production of such parts is discontinued. In repairing the monitor, EIZO and Distributors will use renewal parts which comply with our QC standards.

The Warranty is valid only in the countries or territories where the Distributors are located. The Warranty does not restrict any legal rights of the Original Purchaser.

Notwithstanding any other provision of this Warranty, EIZO and Distributors shall have no obligation under this Warranty whatsoever in any of the cases as set forth below:

- (a) Any defect of the Product caused by freight damage, modification, alteration, abuse, misuse, accident, incorrect installation, disaster, faulty maintenance and/or improper repair by third party other than EIZO and Distributors;
- (b) Any incompatibility of the Product due to possible technical innovations and/or regulations;
- (c) Any deterioration of the sensor;
- (d) Any deterioration of display performance caused by the deterioration of expendable parts such as the LCD panel and/or backlight, etc. (e.g. changes in brightness, changes in brightness uniformity, changes in color, changes in color uniformity, defects in pixels including burnt pixels, etc.);
- (e) Any defect of the Product caused by external equipment;
- (f) Any defect of the Product on which the original serial number has been altered or removed;
- (g) Any defect of the Product caused by liquid leaking from battery;
- (h) Any normal deterioration of the product, particularly that of consumables, accessories, and/or attachments (e.g. batteries, buttons, rotating parts, remote control, cables, User’s Manual, etc.); and
- (i) Any deformation, discoloration, and/or warp of the exterior of the product including that of the surface of the LCD panel.

To obtain service under the Warranty, the Original Purchaser must deliver the Product, freight prepaid, in its original package or other adequate package affording an equal degree of protection, assuming the risk of damage and/or loss in transit, to the local Distributor. The Original Purchaser must present proof of purchase of the Product and the date of such purchase when requesting services under the Warranty.

The Warranty Period for any replaced and/or repaired product under this Warranty shall expire at the end of the original Warranty Period.

EIZO OR DISTRIBUTORS ARE NOT RESPONSIBLE FOR ANY DAMAGE TO, OR LOSS OF, DATA OR OTHER INFORMATION STORED IN ANY MEDIA OR ANY PART OF ANY PRODUCT RETURNED TO EIZO OR DISTRIBUTORS FOR REPAIR.

EIZO AND DISTRIBUTORS MAKE NO FURTHER WARRANTIES, EXPRESSED OR IMPLIED, WITH RESPECT TO THE PRODUCT AND ITS QUALITY, PERFORMANCE, MERCHANTABILITY OR FITNESS FOR ANY PARTICULAR USE. IN NO EVENT SHALL EIZO OR DISTRIBUTORS BE LIABLE FOR ANY INCIDENTAL, INDIRECT, SPECIAL, CONSEQUENTIAL OR OTHER DAMAGE WHATSOEVER (INCLUDING, WITHOUT LIMITATION, DAMAGES FOR LOSS OF PROFIT, BUSINESS INTERRUPTION, LOSS OF BUSINESS INFORMATION, OR ANY OTHER PECUNIARY LOSS) ARISING OUT OF THE USE OR INABILITY TO USE THE PRODUCT OR IN ANY CONNECTION WITH THE PRODUCT, WHETHER BASED ON CONTRACT, TORT, NEGLIGENCE, STRICT LIABILITY OR OTHERWISE, EVEN IF EIZO OR DISTRIBUTORS HAVE BEEN ADVISED OF THE POSSIBILITY OF SUCH DAMAGES. THIS EXCLUSION ALSO INCLUDES ANY LIABILITY WHICH MAY ARISE OUT OF THIRD PARTY CLAIMS AGAINST THE ORIGINAL PURCHASER. THE ESSENCE OF THIS PROVISION IS TO LIMIT THE POTENTIAL LIABILITY OF EIZO AND DISTRIBUTORS ARISING OUT OF THIS LIMITED WARRANTY AND/OR SALES.

## BEGRENZTE GARANTIE

EIZO Corporation (im Weiteren als „**EIZO**“ bezeichnet) und die Vertragsimporteure von EIZO (im Weiteren als „**Vertrieb(e)**“ bezeichnet) garantieren dem ursprünglichen Käufer (im Weiteren als „**Erstkäufer**“ bezeichnet), der das in diesem Dokument vorgegebene Produkt (im Weiteren als „**Produkt**“ bezeichnet) von EIZO oder einem Vertrieb erworben hat, gemäß den Bedingungen dieser beschränkten Garantie (im Weiteren als „**Garantie**“ bezeichnet), dass EIZO und der Vertrieb nach eigenem Ermessen das Produkt entweder kostenlos reparieren oder austauschen, falls der Erstkäufer innerhalb der Garantiefrist (weiter unten festgelegt) eine Fehlfunktion bzw. Beschädigung des Produkts feststellt, die während des normalen Gebrauchs des Produkts gemäß den Anweisungen des zum Lieferumfang des Produkts gehörenden Benutzerhandbuchs (im Weiteren als „**Benutzerhandbuch**“ bezeichnet) aufgetreten ist.

Die Dauer der Garantieleistung (im Weiteren als „**Garantiefrist**“ bezeichnet) beträgt drei (3) Jahre ab dem Kaufdatum des Produkts. EIZO und die Vertriebe übernehmen über den Rahmen dieser Garantie hinaus hinsichtlich des Produkts keinerlei Haftung oder Verpflichtung dem Erstkäufer oder Dritten gegenüber.

EIZO und die Vertriebe verpflichten sich, Ersatzteile für das Produkt über einen Zeitraum von sieben (7) Jahren nach Einstellung der Produktion der Ersatzteile zu lagern bzw. anzubieten. EIZO und seine Vertriebspartner verpflichten sich, bei einer etwaigen Reparatur des Monitors ausschließlich Produkte gemäß den EIZO-Qualitätssicherungsstandards zu verwenden.

Diese Garantie gilt nur in Ländern oder Gebieten, in denen sich Vertriebe befinden. Die gesetzlichen Gewährleistungsrechte des Erstkäufers gegenüber dem Verkäufer werden durch diese Garantie nicht berührt.

EIZO und die Vertriebe besitzen im Rahmen dieser Garantie keinerlei Verpflichtung in den folgenden Fällen:

- (a) Produktdefekte, die auf Frachtschäden, Modifikation, Nachgestaltung, Missbrauch, Fehlbedienung, Unfälle, unsachgemäße Installation, Naturkatastrophen, fehlerhafte Wartung und/oder unsachgemäße Reparatur durch eine andere Partei als EIZO und die Vertriebe zurückzuführen sind.
- (b) Eine Inkompatibilität des Produkts aufgrund von technischen Neuerungen und/oder neuen Bestimmungen, die nach dem Kauf in Kraft treten.
- (c) Jegliche Verschlechterung des Sensors.
- (d) Jegliche Verschlechterung der Bildschirmleistung, die durch Verschleißteile wie das LCD-Panel und/oder die Hintergrundbeleuchtung usw. hervorgerufen werden (z.B. Veränderungen von Helligkeit oder Helligkeitsverteilung, Veränderungen von Farbe oder Farbverteilung, Pixeldefekte einschließlich von durchgebrannten Pixeln usw.).
- (e) Produktdefekte, die durch externe Geräte verursacht werden.
- (f) Jeglicher Defekt eines Produkts, dessen ursprüngliche Seriennummer geändert oder entfernt wurde.
- (g) Produktdefekte, die durch Austritt von Batterieflüssigkeit verursacht werden.
- (h) Normale Abnutzung des Produkts, insbesondere von Verbrauchsteilen, Zubehörteilen und/oder Beilagen (z.B. Batterien, Tasten, drehbare Teile, Fernbedienung, Kabel, Benutzerhandbuch usw.); sowie
- (i) Verformungen, Verfärbungen und/oder Verziehungen am Produktäußeren, einschließlich der Oberfläche des LCD-Panels.

Bei Inanspruchnahme der Garantieleistung ist der Erstkäufer verpflichtet, das Produkt auf eigene Kosten und in der Originalverpackung bzw. einer anderen geeigneten Verpackung, die einen gleichwertigen Schutz gegen Transportschäden bietet, an den örtlichen Vertrieb zu übersenden, wobei der Erstkäufer das Transportrisiko gegenüber Schäden und/oder Verlust trägt. Zum Zeitpunkt der Inanspruchnahme der Garantieleistung muss der Erstkäufer einen Verkaufsbeleg vorweisen, auf dem das Kaufdatum angegeben ist.

Die Garantiefrist für ein im Rahmen dieser Garantie ausgetauschtes und/oder repariertes Produkt erlischt nach Ablauf der ursprünglichen Garantiefrist.

EIZO ODER DIE EIZO-VERTRAGSIMPORTEURE HAFTEN NICHT FÜR ZERSTÖRTE DATENBESTÄNDE ODER DIE KOSTEN DER WIEDERBESCHAFFUNG DIESER DATENBESTÄNDE AUF JEDLICHEN DATENTRÄGERN ODER TEILEN DES PRODUKTS, DIE IM RAHMEN DER GARANTIE BEI EIZO ODER DEN EIZO-VERTRAGSIMPORTEUREN ZUR REPARATUR EINGEREICHT WURDEN.

EIZO UND DIE EIZO-VERTRAGSIMPORTEURE GEBEN WEDER EXPLIZITE NOCH IMPLIZITE GARANTIE IN BEZUG AUF DIESES PRODUKT UND SEINE QUALITÄT, LEISTUNG, VERKÄUFLICHKEIT ODER EIGNUNG FÜR EINEN BESTIMMTEN ZWECK. AUF KEINEN FALL SIND EIZO ODER DIE EIZO-VERTRAGSIMPORTEURE VERANTWORTLICH FÜR JEDLICHE ZUFÄLLIGE, INDIREKTE, SPEZIELLE, FOLGE- ODER ANDERE SCHÄDEN JEDLICHER ART (EINSCHLIESSLICH OHNE JEDE BEGRENZUNG SCHÄDEN BEZÜGLICH PROFITVERLUST, GESCHÄFTSUNTERBRECHUNG, VERLUST VON GESCHÄFTSINFORMATION ODER JEDLICHE ANDEREN FINANZIELLEN EINBUSSEN), DIE DURCH DIE VERWENDUNG DES PRODUKTES ODER DIE UNFÄHIGKEIT ZUR VERWENDUNG DES PRODUKTES ODER IN JEDLICHER BEZIEHUNG MIT DEM PRODUKT, SEI ES BASIEREND AUF VERTRAG, SCHADENSERSATZ, NACHLAESSIGKEIT, STRIKTE HAFTPFLICHT ODER ANDEREN FORDERUNGEN ENTSTEHEN, AUCH WENN EIZO UND DIE EIZO-VERTRAGSIMPORTEURE IM VORAUS ÜBER DIE MÖGLICHKEIT SOLCHER SCHÄDEN INFORMIERT WURDEN. DIESER AUSSCHLUSS ENTHÄLT AUCH JEDE HAFTPFLICHT, DIE AUS FORDERUNGEN DRITTER GEGEN DEN ERSTKÄUFER ENTSTEHEN KANN. ZWECK DIESER KLAUSEL IST ES, DIE HAFTUNG VON EIZO UND DEN VERTRIEBEN GEGENÜBER FORDERUNGEN ZU BEGRENZEN, DIE AUS DIESER BESCHRÄNKTEN GARANTIE UND/ODER DEM VERKAUF ENTSTEHEN KÖNNEN.

## GARANTIE LIMITÉE

EIZO Corporation (ci-après dénommé « **EIZO** ») et les distributeurs autorisés par EIZO (ci-après dénommés « **Distributeurs** »), sous réserve et conformément aux termes de cette garantie limitée (ci-après dénommée « **Garantie** »), garantissent à l'acheteur initial (ci-après dénommé « **Acheteur initial** ») du produit spécifié dans la présente (ci-après dénommé « **Produit** ») acheté auprès d'EIZO ou de Distributeurs agréés EIZO, que EIZO et ses Distributeurs auront pour option de réparer ou remplacer gratuitement le Produit si l'Acheteur initial constate, pendant la Période de garantie (définie ci-dessous), qu'il y a un dysfonctionnement ou que le Produit a subi un dommage dans le cadre d'une utilisation normale du Produit conformément à la description du mode d'emploi qui accompagne le Produit (ci-après dénommé « **Manuel d'utilisation** »).

La période de cette Garantie est de trois (3) ans à partir de la date d'achat du Produit (ci-après dénommée « Période de Garantie »). EIZO et ses Distributeurs déclinent toute responsabilité ou obligation concernant ce Produit face à l'Acheteur initial ou à toute autre personne à l'exception de celles stipulées dans la présente Garantie.

EIZO et ses Distributeurs cesseront de tenir ou conserver en stock toute pièce de ce Produit après l'expiration de la période de sept (7) ans suivant l'arrêt de la production de telles pièces. Pour réparer le moniteur, EIZO et ses distributeurs utiliseront des pièces de rechange conformes à nos normes de contrôle qualité.

La Garantie est valable uniquement dans les pays ou les territoires où se trouvent les Distributeurs. La Garantie ne limite aucun des droits reconnus par la loi à l'Acheteur initial.

Nonobstant toute autre clause de cette Garantie, EIZO et ses Distributeurs n'auront d'obligation dans le cadre de cette Garantie pour aucun des cas énumérés ci-dessous :

- (a) Tout défaut du Produit résultant de dommages occasionnés lors du transport, d'une modification, d'une altération, d'un abus, d'une mauvaise utilisation, d'un accident, d'une installation incorrecte, d'un désastre, d'un entretien et/ou d'une réparation incorrects effectués par une personne autre que EIZO ou ses Distributeurs ;
- (b) Toute incompatibilité du Produit résultant d'améliorations techniques et/ou réglementations possibles ;
- (c) Toute détérioration du capteur ;
- (d) Toute détérioration des performances d'affichage causée par la détérioration des éléments consommables tels que le panneau LCD et/ou le rétroéclairage, etc. (par exemple des changements de luminosité, des changements de l'uniformité de la luminosité, des modifications de couleur, des changements de l'uniformité des couleurs, des défauts de pixels y compris des pixels brûlés, etc.);
- (e) Tout défaut du Produit causé par un appareil externe ;
- (f) Tout défaut d'un Produit sur lequel le numéro de série original a été altéré ou supprimé ;
- (g) Tout défaut du Produit causé par un écoulement du liquide contenu dans les piles ;
- (h) Toute détérioration normale du Produit, particulièrement celle des consommables, des accessoires et/ou des pièces reliées au Produit (piles, touches, éléments pivotants, télécommande, câbles, Manuel d'utilisation etc.), et
- (i) Toute déformation, décoloration, et/ou gondolage de l'extérieur du Produit, y compris celle de la surface du panneau LCD.

Pour bénéficier d'un service dans le cadre de cette Garantie, l'Acheteur initial doit renvoyer le Produit port payé, dans son emballage d'origine ou tout autre emballage approprié offrant un degré de protection équivalent, au Distributeur local, et assumera la responsabilité des dommages et/ou perte possibles lors du transport. L'Acheteur initial doit présenter une preuve d'achat du Produit comprenant sa date d'achat pour bénéficier de ce service dans le cadre de la Garantie.

La Période de garantie pour tout Produit remplacé et/ou réparé dans le cadre de cette Garantie expirera à la fin de la Période de garantie initiale.

**EIZO OU SES DISTRIBUTEURS NE SAURAIENT ÊTRE TENUS RESPONSABLES DES DOMMAGES OU PERTES DE DONNÉES OU D'AUTRES INFORMATIONS STOCKÉES DANS UN MÉDIA QUELCONQUE OU UNE AUTRE PARTIE DU PRODUIT RENVOYÉ À EIZO OU AUX DISTRIBUTEURS POUR RÉPARATION.**

AUCUNE AUTRE GARANTIE, EXPLICITE OU TACITE, N'EST OFFERTE PAR EIZO ET SES DISTRIBUTEURS CONCERNANT LE PRODUIT ET SES QUALITÉS, PERFORMANCES, QUALITÉ MARCHANDE OU ADAPTATION À UN USAGE PARTICULIER. EN AUCUN CAS, EIZO OU SES DISTRIBUTEURS NE SERONT RESPONSABLES DES DOMMAGES FORTUITS, INDIRECTS, SPÉCIAUX, INDUITS, OU DE TOUT AUTRE DOMMAGE QUEL QU'IL SOIT (Y COMPRIS, SANS LIMITATION, LES DOMMAGES RÉSULTANT D'UNE PERTE DE PROFIT, D'UNE INTERRUPTION D'ACTIVITÉS, D'UNE PERTE DE DONNÉES COMMERCIALES, OU DE TOUT AUTRE MANQUE À GAGNER) RÉSULTANT DE L'UTILISATION OU DE L'INCAPACITÉ D'UTILISER LE PRODUIT OU AYANT UN RAPPORT QUELCONQUE AVEC LE PRODUIT, QUE CE SOIT SUR LA BASE D'UN CONTRAT, D'UN TORT, D'UNE NÉGLIGENCE, D'UNE RESPONSABILITÉ STRICTE OU AUTRE, MÊME SI EIZO OU SES DISTRIBUTEURS ONT ÉTÉ AVERTIS DE LA POSSIBILITÉ DE TELS DOMMAGES. CETTE LIMITATION INCLUT AUSSI TOUTE RESPONSABILITÉ QUI POURRAIT ÊTRE SOULEVÉE LORS DES RÉCLAMATIONS D'UN TIERS CONTRE L'ACHETEUR INITIAL. L'ESSENCE DE CETTE CLAUSE EST DE LIMITER LA RESPONSABILITÉ POTENTIELLE DE EIZO ET DE SES DISTRIBUTEURS RÉSULTANT DE CETTE GARANTIE LIMITÉE ET/OU DES VENTES.



## GARANTÍA LIMITADA

EIZO Corporation (en lo sucesivo “EIZO”) y sus distribuidores autorizados (en lo sucesivo los “Distribuidores”), con arreglo y de conformidad con los términos de esta garantía limitada (en lo sucesivo la “Garantía”), garantizan al comprador original (en lo sucesivo el “Comprador original”) que compró el producto especificado en este documento (en lo sucesivo el “Producto”) a EIZO o a sus Distribuidores, que EIZO y sus Distribuidores, a su propio criterio, repararán o sustituirán el Producto de forma gratuita si el Comprador original detecta dentro del periodo de la Garantía (indicado posteriormente) que el Producto no funciona correctamente o que se ha averiado durante el uso normal del mismo de acuerdo con las indicaciones del manual de instrucciones suministrado con el Producto (en lo sucesivo el “Manual del usuario”).

El periodo de esta Garantía es de tres (3) años a partir de la fecha de compra del Producto (en adelante designado como el “Periodo de Garantía”). EIZO y sus Distribuidores no tendrán ninguna responsabilidad ni obligación con respecto al Producto para con el Comprador original ni con terceros que no sean las estipuladas en la presente Garantía.

EIZO y sus Distribuidores no estarán obligados a suministrar cualquier recambio del Producto una vez pasados siete (7) años desde que se deje de fabricar el mismo. Para la reparación del monitor, EIZO y los distribuidores utilizarán repuestos que cumplan con nuestros estándares de control de calidad.

La Garantía es válida sólo en los países y territorios donde están ubicados los Distribuidores. La Garantía no restringe ningún derecho legal del Comprador original.

A pesar de las estipulaciones de esta Garantía, EIZO y sus Distribuidores no tendrán obligación alguna bajo esta Garantía en ninguno de los casos expuestos a continuación:

- (a) Cualquier defecto del Producto causado por daños en el transporte, modificación, alteración, abuso, uso incorrecto, accidente, instalación incorrecta, desastre, mantenimiento incorrecto y/o reparación indebida realizada por un tercero que no sea EIZO o sus Distribuidores.
- (b) Cualquier incompatibilidad del Producto debida a posibles innovaciones técnicas y/o reglamentaciones.
- (c) Cualquier deterioro del sensor.
- (d) Cualquier deterioro en el rendimiento de la visualización causado por fallos en las piezas consumibles como el panel LCD y/o la "Backlight", etc. (p. ej. cambios de brillo, cambios de uniformidad del brillo, cambios de color, cambios de uniformidad del color, defectos de píxeles, incluyendo píxeles muertos, etc.).
- (e) Cualquier defecto del Producto causado por un equipo externo.
- (f) Cualquier defecto del Producto en el que haya sido alterado o borrado el número de serie original.
- (g) Cualquier defecto del Producto casusado por fugas de líquido de las pilas.
- (h) Cualquier deterioro normal del Producto, y en particular de las piezas consumibles, accesorios y demás (p. ej. pilas, botones, piezas giratorias, mando a distancia, cables, Manual del usuario, etc.).
- (i) Cualquier deformación, decoloración y/o alabeo del exterior del Producto incluida la superficie del panel LCD.

Para obtener servicio en los términos de esta Garantía, el Producto deberá ser enviado por el Comprador original, a su Distribuidor local, con el transporte previamente pagado, en el embalaje original u otro embalaje adecuado que ofrezca el mismo grado de protección, asumiendo el riesgo de daños y/o pérdida del Producto durante el transporte. El Comprador original deberá presentar un comprobante de compra del Producto en el que se refleje la fecha de compra del mismo cuando lo solicite el servicio de Garantía.

El Periodo de garantía para cualquier Producto reemplazado y/o reparado en los términos de esta Garantía expirará al vencer el Periodo de garantía original.

EIZO O LOS DISTRIBUIDORES AUTORIZADOS DE EIZO NO SE RESPONSABILIZAN DE NINGÚN DAÑO O PÉRDIDA QUE PUEDAN SUFRIR LOS DATOS U OTRA INFORMACIÓN ALMACENADA EN CUALQUIER MEDIO O CUALQUIER PARTE DE CUALQUIER PRODUCTO DEVUELTO A EIZO O A LOS DISTRIBUIDORES DE EIZO PARA SU REPARACIÓN.

EIZO Y LOS DISTRIBUIDORES AUTORIZADOS DE EIZO NO OFRECEN NINGUNA OTRA GARANTÍA, IMPLÍCITA NI EXPLÍCITA, CON RESPECTO AL PRODUCTO Y A SU CALIDAD, RENDIMIENTO, COMERCIABILIDAD E IDONEIDAD PARA CUALQUIER USO EN PARTICULAR. EN NINGÚN CASO SERÁN EIZO O LOS DISTRIBUIDORES AUTORIZADOS DE EIZO RESPONSABLES DE NINGÚN DAÑO EMERGENTE, INDIRECTO, ESPECIAL, INHERENTE O CUALQUIERA QUE SEA (INCLUYENDO, SIN LIMITACIÓN, DAÑOS POR LUCRO CESANTE, INTERRUPCIÓN DE LA ACTIVIDAD COMERCIAL, PÉRDIDA DE INFORMACIÓN COMERCIAL O CUALQUIER OTRA PÉRDIDA PECUNIARIA) QUE SE DERIVE DEL USO O IMPOSIBILIDAD DE USO DEL PRODUCTO O EN RELACIÓN CON EL PRODUCTO, YA SEA BASADO EN CONTRATO, POR AGRAVIO, NEGLIGENCIA, ESTRICTA RESPONSABILIDAD O CUALQUIERA QUE SEA, AUN CUANDO SE HAYA ADVERTIDO A EIZO O A LOS DISTRIBUIDORES DE EIZO DE LA POSIBILIDAD DE TALES DAÑOS. ESTA EXCLUSIÓN TAMBIÉN ABARCA CUALQUIER RESPONSABILIDAD QUE PUEDA DERIVARSE DE RECLAMACIONES HECHAS POR UN TERCERO CONTRA EL COMPRADOR ORIGINAL. LA ESENCIA DE ESTA ESTIPULACIÓN ES LIMITAR LA RESPONSABILIDAD POTENCIAL DE EIZO Y LOS DISTRIBUIDORES QUE PUDIERA DERIVARSE DE ESTA GARANTÍA LIMITADA Y/O VENTAS.



## GARANZIA LIMITATA

EIZO Corporation (a cui si farà riferimento da qui in poi con “**EIZO**”) ed i Distributori autorizzati da EIZO (a cui si farà riferimento da qui in poi con “**Distributori**”) garantiscono, secondo i termini di questa garanzia limitata (a cui si farà riferimento da qui in poi con “**Garanzia**”) all’acquirente originale (a cui si farà riferimento da qui in poi con “**Acquirente originale**”) che ha acquistato il prodotto specificato in questo documento (a cui si farà riferimento da qui in poi con “**Prodotto**”) da EIZO o dai suoi Distributori, che EIZO e i distributori, a loro discrezione, ripareranno o sostituiranno il Prodotto senza addebito se l’Acquirente originale trova, entro il periodo della Garanzia (definito sotto), che il Prodotto malfunziona e si è danneggiato nel corso del suo normale utilizzo osservando le indicazioni del manuale di istruzioni allegato al Prodotto (a cui si farà riferimento da qui in poi con “**Manuale utente**”).

Il periodo di questa Garanzia è di tre (3) anni dalla data di acquisto del Prodotto (a cui si farà riferimento da qui in poi con “Periodo di Garanzia”). EIZO e i suoi Distributori non si assumono alcuna responsabilità e non hanno alcun obbligo riguardo al Prodotto verso l’Acquirente originale o terzi diversi da quelli relativi a questa Garanzia.

EIZO e i suoi Distributori cesseranno di tenere o di conservare qualsiasi ricambio del Prodotto allo scadere di sette (7) anni dopo che la produzione di tali ricambi è stata terminata. Per la riparazione del monitor, EIZO e i Distributori utilizzeranno parti di ricambio conformi ai nostri standard di controllo della qualità.

La Garanzia è valida soltanto nei paesi dove ci sono i Distributori EIZO. La Garanzia non limita alcun diritto legale dell’Acquirente originale.

Indipendentemente da qualsiasi altra condizione di questa Garanzia, EIZO e i suoi Distributori non avranno alcun obbligo derivante da questa Garanzia in ognuno dei casi elencati di seguito:

- (a) Qualsiasi difetto del Prodotto causato da danni di trasporto, modifiche, alterazioni, abusi, usi impropri, incidenti, installazione errata, calamità, manutenzione errata e/o riparazioni improprie eseguite da terze parti che non siano EIZO o i suoi Distributori.
- (b) Qualsiasi incompatibilità del Prodotto dovuta a possibili innovazioni tecniche e/o normative.
- (c) Qualsiasi deterioramento del sensore.
- (d) Qualsiasi deterioramento delle prestazioni dello schermo causato dal deterioramento delle parti consumabili, come il pannello LCD e/o la retroilluminazione, ecc. (per esempio: i cambiamenti di luminosità, cambiamenti di uniformità della luminosità, i cambiamenti di colore, i cambiamenti di uniformità del colore, i difetti dei pixel, inclusi i pixel bruciati, ecc.).
- (e) Qualsiasi difetto del Prodotto causato da apparecchiature esterne.
- (f) Qualsiasi difetto del Prodotto in cui il numero di serie originale sia stato alterato o rimosso.
- (g) Qualsiasi difetto del Prodotto causato dalla fuoriuscita di liquido dalle pile.
- (h) Qualsiasi normale deterioramento del Prodotto, in particolar modo nelle sue parti di consumo, accessori, e/o attacchi (per esempio: pile, tasti, parti rotanti, telecomando, cavi, Manuale dell’utente, ecc.).
- (i) Qualsiasi tipo di deformazione, scolorimento, e/o di involucro esterno del Prodotto inclusa la superficie del pannello LCD.

Per ricevere assistenza tecnica con questa Garanzia, l’Acquirente originale deve inviare il Prodotto, con trasporto pre-pagato, nella sua confezione originale o altra confezione adeguata che fornisce un livello analogo di protezione, assumendosi il rischio di danni e/o perdita in transito, al Distributore locale. L’Acquirente originale deve presentare la prova di acquisto che stabilisce la data di acquisto del Prodotto quando richiede servizio sotto Garanzia.

Il Periodo di garanzia per qualsiasi Prodotto sostituito e/o riparato sotto questa Garanzia scade alla fine del Periodo di garanzia originale.

**EIZO O I SUOI DISTRIBUTORI NON SONO RESPONSABILI PER QUALSIASI DANNO O PERDITA DI DATI O ALTRE INFORMAZIONI MEMORIZZATI SU QUALSIASI SUPPORTO O QUALSIASI PARTE DI QUALSIASI PRODOTTO INVIATO A EIZO O I SUOI DISTRIBUTORI PER RIPARAZIONI.**

**EIZO E I SUOI DISTRIBUTORI NON OFFRONO ALCUNA GARANZIA ADDIZIONALE, IMPLICITA O ESPLICITA, RIGUARDO IL PRODOTTO E LA SUA QUALITÀ, PRESTAZIONI, VENDIBILITÀ O APPROPRIATEZZA PER QUALSIASI USO PARTICOLARE. IN NESSUN CASO EIZO O I DISTRIBUTORI EIZO AUTORIZZATI SARANNO RESPONSABILI PER QUALSIASI DANNO ACCIDENTALE, INDIRETTO, SPECIALE, CONSEGUENTE O DI QUALSIASI ALTRA NATURA (INCLUSI, SENZA LIMITI, DANNI PER PERDITA DI PROFITTI, INTERRUZIONE DELLE ATTIVITÀ, PERDITA DI INFORMAZIONI D’AFFARI O QUALSIASI ALTRA PERDITA PECUNIARIA) DERIVANTI DALL’USO O DALL’IMPOSSIBILITÀ DI USARE IL PRODOTTO O IN QUALSIASI RELAZIONE AL PRODOTTO, SIA SU BASE DI CONTRATTO, TORTO, NEGLIGENZA, STRETTA RESPONSABILITÀ O ALTRIMENTI, ANCHE SE EIZO O I DISTRIBUTORI EIZO AUTORIZZATI SONO STATI AVVERTITI DELLA POSSIBILITÀ DI TALI DANNI. QUESTA ESCLUSIONE INCLUDE ANCHE QUALSIASI RESPONSABILITÀ CHE POSSA INSORGERE DA RECLAMI DI TERZI CONTRO L’ACQUIRENTE ORIGINALE. L’ESSENZA DI QUESTO PROVVEDIMENTO È LIMITARE LA RESPONSABILITÀ POTENZIALE DI EIZO E DEI DISTRIBUTORI DERIVANTE DA QUESTA GARANZIA LIMITATA E/O DALLE VENDITE.**

## BEGRÄNSAD GARANTI

EIZO Corporation (nedan kallat "**EIZO**") och EIZOs auktoriserade distributörer (nedan kallade "**Distributörer**") garanterar i enlighet med villkoren i denna begränsade garanti (nedan kallad "**Garantin**") den ursprunglige köparen (nedan kallad den "**Ursprunglige köparen**") som köpte den i dokumentet specificerade produkten (nedan kallad "**Produkten**") från EIZO eller Distributörer, att EIZO eller Distributörer enligt eget gottfinnande kostnadsfritt antingen reparera eller byta ut den defekta Produkten om den Ursprunglige köparen inom Garantiperioden (definieras nedan) upptäcker att Produkten fungerar felaktigt eller skadas under normal användning av Produkten i enlighet med beskrivningen i bruksanvisningen (nedan kallad "**Bruksanvisning**").

Garantiperioden är begränsad till tre (3) år från datumet för Produktens inköp (här kallad "Garantiperioden"). EIZO och Distributörer ska inte under några villkor ha något annat ansvar än vad som anges i denna garanti gällande Produkten i relation till den Ursprunglige köparen eller tredje part.

EIZO och Distributörer kommer att upphöra med lagerhållning av Produktens delar efter sju (7) år efter att produktionen av dessa delar upphört. När skärmen repareras använder EIZO och distributörer reservdelar som uppfyller våra kvalitetsstandarder.

Garantin är endast giltig i de länder där det finns Distributörer. Garantin begränsar inte några av den Ursprunglige köparens lagstadgade rättigheter.

Oavsett andra villkor i denna garanti ska inte EIZO Distributörer under några villkor ha något ansvar i något av de fall som beskrivs nedan:

- (a) När någon bristfällighet hos Produkten kan härledas till att ha uppstått vid frakt, modifiering, ändring, felaktigt handhavande, olycka, felaktig installation, katastrof, felaktigt underhåll och/eller felaktig reparation utförd av tredje part annan än EIZO och Distributörer.
- (b) Alla former av inkompatibilitet hos Produkten på grund av möjliga tekniska innovationer och/eller bestämmelser.
- (c) Alla försämringar av sensorn.
- (d) Alla försämringar av bildens prestanda beroende på förbrukningsdelar så som LCD-panel och/eller bakgrundsbelysning etc. (t.ex. ändringar i ljusstyrka, jämnhet i ljusstyrka, färg, färgjämnhet, defekta pixlar och/eller fast lysande pixlar etc.).
- (e) Alla defekter hos Produkten som orsakats av extern utrustning.
- (f) Alla defekter hos Produkten på vilken det ursprungliga serienumret har ändrats eller avlägsnats.
- (g) Alla produktfel som orsakas av vätska som läcker från batteriet.
- (h) All normal försämring av Produkten, speciellt förbrukningsartiklar, tillbehör och/eller yttre delar (t.ex. batterier, knappar, roterande delar, fjärrkontroll, kablar, Bruksanvisningen etc.).
- (i) Varje deformation, missfärgning och/eller skevhet av Produktens yttre inklusive ytan på LCD-panelen.

För att erhålla service under denna garanti måste den Ursprunglige köparen (med hänseende till risken för skada och/eller förlust under transport) leverera Produkten till närmaste Distributör med förebetalad frakt, i dess ursprungliga förpackning eller annan fullgod förpackning som ger likvärdigt skydd. Den Ursprunglige köparen måste kunna visa inköpsbevis för Produkten som klagör Produktens inköpsdatum vid begäran av garantiservice.

Garantiperioden för alla utbytta och/eller reparerade produkter under denna garanti skall upphöra vid utgången av den ursprungliga Garantiperioden.

**EIZO ELLER DISTRIBUTÖRER ÄR INTE ANSVARIGA FÖR NÅGON FORM AV SKADA ELLER FÖRLUST AV DATA ELLER ANNAN INFORMATION SOM HAR LAGRATS I NÅGON FORM AV MEDIA ELLER ANNAN DEL AV NÅGON PRODUKT SOM HAR RETURNERATS TILL EIZO ELLER DISTRIBUTÖRER FÖR REPARATION.**

**EIZO OCH DISTRIBUTÖRERNA GARANTERAR INGET, UTTRYCKLIGEN ELLER UNDERFÖRSTÅTT, VAD BETRÄFFAR PRODUKTEN OCH DESS KVALITET, PRESTANDA, SÄLJBARHET ELLER LÄMPLIGHET FÖR NÅGON FORM AV SPECIELL ANVÄNDNING. UNDER INGA OMSTÄNDIGHETER SKALL EIZO ELLER DISTRIBUTÖRERNA HÅLLAS ANSVARIGA FÖR NÅGRA SOM HELST UNDERORDNADE, INDIREKTA, SPECIELLA, DÄRAV FÖLJANDE ELLER ÖVRIGA SKADOR (INKLUSIVE, UTAN BEGRÄNSNING TILL, SKADOR FÖR FÖRLUST AV INKOMST, AVBRUTEN AFFÄRSRÖRELSE, FÖRLUST AV AFFÄRSINFORMATION ELLER ANNAN SÄRSKILD FÖRLUST) SOM UPPSTÅTT SOM ETT RESULTAT AV ANVÄNDNING ELLER OFÖRMÅGA ATT ANVÄNDA PRODUKTEN ELLER I NÅGON FORM AV ANSLUTNING TILL PRODUKTERNA, VARE SIG DETTA GRUNDAS PÅ KONTRAKT, ÅTALBAR HANDLING, FÖRSUMLIGHET, ANSVARSSKYLDIGHET ELLER ANNAT, ÄVEN OM EIZO ELLER DISTRIBUTÖRERNA HAR INFORMERATS BETRÄFFANDE MÖJLIGHET ATT SÅDANA SKADOR FÖRELIGGER. DETTA UNDANTAG OMFATTAR ÄVEN ALL FORM AV ANSVARSSKYLDIGHET SOM KAN UPPSTÅ GENOM EN TREDJE PARTS ANSPRÅK GENTEMOT DEN URSPRUNGLIGE KÖPAREN. GRUNDBESTÄNDSDELEN I BESTÄMMELEN ÄR ATT BEGRÄNSA DET EVENTUELLA ANSVARSTAGANDET FÖR EIZO OCH DISTRIBUTÖRERNA SOM KAN UPPSTÅ GENOM DENNA BEGRÄNSADE GARANTI OCH/ELLER FÖRSÄLJNING.**

## ΠΕΡΙΟΡΙΣΜΕΝΗ ΕΓΓΥΗΣΗ

Η EIZO Corporation (στο εξής «**EIZO**») και οι διανομείς που εξουσιοδοτεί η EIZO (στο εξής «**Διανομείς**») παρέχουν εγγύηση, υποκειμένη και σύμφωνα με τους όρους της παρούσας περιορισμένης εγγύησης (στο εξής «**Εγγύηση**»), στον αρχικό αγοραστή (στο εξής «**Αρχικός Αγοραστής**») ο οποίος αγόρασε το προϊόν που καθορίζεται στο παρόν έγγραφο (στο εξής «**Προϊόν**») από την EIZO ή τους Διανομείς, η οποία εξασφαλίζει ότι η EIZO και οι Διανομείς, σύμφωνα με τη διακριτή ευχέρειά τους, είτε θα επισκευάσουν είτε θα αντικαταστήσουν το Προϊόν χωρίς χρέωση εάν ο Αρχικός Αγοραστής αντιληφθεί εντός της Περιόδου Εγγύησης (ορίζεται κατωτέρω) ότι το Προϊόν δυσλειτουργεί ή έχει υποστεί βλάβη κατά τη διάρκεια κανονικής χρήσης του Προϊόντος σύμφωνα με την περιγραφή στο εγχειρίδιο χρήσης που συνοδεύει το Προϊόν (στο εξής «**Εγχειρίδιο Χρήστη**»).

Η περίοδος της παρούσας Εγγύησης είναι τρία (3) έτη από την ημερομηνία αγοράς του Προϊόντος (στο εξής «Περίοδος Εγγύησης»). Η EIZO και οι Διανομείς δεν φέρουν καμία ευθύνη ή υποχρέωση όσον αφορά το Προϊόν σε σχέση με τον Αρχικό Αγοραστή ή οποιοδήποτε τρίτο μέρος, ούτε άλλη ευθύνη διαφορετική από αυτήν που παρέχεται στην παρούσα Εγγύηση.

Η EIZO και οι Διανομείς θα παύσουν να διατηρούν ή να αποθηκεύουν τυχόν εξαρτήματα του Προϊόντος κατόπιν της λήξης των επτά (7) ετών μετά τη διακοπή της παραγωγής τέτοιων εξαρτημάτων. Κατά την επισκευή της οθόνης, η EIZO και οι Διανομείς θα χρησιμοποιήσουν ανταλλακτικά επισκευής που συμμορφώνονται με τα πρότυπά μας για τη Διασφάλιση Ποιότητας.

Η Εγγύηση ισχύει μόνο σε χώρες ή περιοχές όπου βρίσκονται οι Διανομείς. Η Εγγύηση δεν περιορίζει οποιαδήποτε νόμιμα δικαιώματα του Αρχικού Αγοραστή.

Λαμβανομένης υπόψη κάθε διάταξης της παρούσας Εγγύησης, η EIZO και οι Διανομείς δεν θα έχουν καμία απολύτως υποχρέωση σύμφωνα με την παρούσα Εγγύηση σε οποιαδήποτε από τις περιπτώσεις που διατυπώνονται κατωτέρω:

- (α) Τυχόν ελάττωμα του Προϊόντος που προκαλείται από ζημιά κατά τη μεταφορά, τροποποίηση, αλλαγή, κατάχρηση, λανθασμένη χρήση, ατύχημα, λανθασμένη εγκατάσταση, καταστροφή, εσφαλμένη συντήρηση ή/και λανθασμένη επισκευή από τρίτο μέρος εκτός της EIZO και των Διανομέων,
- (β) Τυχόν ασυμβατότητα του Προϊόντος λόγω πιθανών τεχνικών καινοτομιών ή/και κανονισμών,
- (γ) Τυχόν επιδείνωση του αισθητήρα,
- (δ) Τυχόν επιδείνωση της απόδοσης οθόνης που προκαλείται από τη φθορά αναλώσιμων εξαρτημάτων όπως της οθόνης LCD ή/και του φωτός υποβάθρου, κτλ. (π.χ. αλλαγές στη φωτεινότητα, αλλαγές στην ομοιομορφία φωτεινότητας, αλλαγές στο χρώμα, αλλαγές στην ομοιομορφία χρώματος, ελαττώματα σε pixel περιλαμβανομένων των καμένων pixel, κτλ.),
- (ε) Τυχόν ελάττωμα του Προϊόντος που προκαλείται από εξωτερικό εξοπλισμό,
- (στ) Τυχόν ελάττωμα του Προϊόντος στο οποίο έχει τροποποιηθεί ή αφαιρεθεί ο γνήσιος αριθμός σειράς,
- (ζ) Τυχόν ελάττωμα του Προϊόντος που προκαλείται από διαρροή υγρού από την μπαταρία,
- (η) Τυχόν φυσιολογική φθορά του προϊόντος, ιδιαίτερα αυτής των αναλώσιμων, των αξεσουάρ ή/και των προσαρτημάτων (π.χ. μπαταρίες, κουμπιά, περιστρεφόμενα μέρη, τηλεχειριστήριο, καλώδια, Εγχειρίδιο Χρήστη, κτλ.), και
- (θ) Τυχόν παραμόρφωση, αποχρωματισμό ή/και διαστρέβλωση του εξωτερικού μέρους του προϊόντος, περιλαμβανομένης της επιφάνειας της οθόνης LCD.

Ο Αρχικός Αγοραστής για να δικαιούται υπηρεσίες επισκευής σύμφωνα με την Εγγύηση, θα πρέπει να παραδώσει το Προϊόν, με πληρωμένα τα μεταφορικά έξοδα, στην αρχική του συσκευασία ή σε άλλη επαρκή συσκευασία με ισότιμο βαθμό προστασίας, αναλαμβάνοντας τον κίνδυνο βλάβης ή/και απώλειας κατά τη μεταφορά, στον τοπικό Διανομέα. Ο Αρχικός Αγοραστής όταν ζητά υπηρεσίες επισκευής σύμφωνα με την Εγγύηση, θα πρέπει να προσκομίζει την απόδειξη αγοράς του Προϊόντος και την ημερομηνία της αγοράς.

Η Περίοδος Εγγύησης για οποιοδήποτε αντικατεστημένο ή/και επισκευασμένο προϊόν σύμφωνα με την παρούσα Εγγύηση λήγει στο τέλος της αρχικής Περιόδου Εγγύησης.

**Η EIZO Ή ΟΙ ΔΙΑΝΟΜΕΙΣ ΔΕΝ ΕΥΘΥΝΟΝΤΑΙ ΓΙΑ ΟΠΟΙΑΔΗΠΟΤΕ ΒΛΑΒΗ Ή ΑΠΩΛΕΙΑ ΔΕΔΟΜΕΝΩΝ Ή ΑΛΛΩΝ ΠΛΗΡΟΦΟΡΙΩΝ ΠΟΥ ΑΠΟΘΗΚΕΥΟΝΤΑΙ ΣΕ ΟΠΟΙΟΔΗΠΟΤΕ ΜΕΣΟ Ή ΟΠΟΙΟΔΗΠΟΤΕ ΑΛΛΟ ΜΕΡΟΣ ΣΕ ΟΠΟΙΟΔΗΠΟΤΕ ΠΡΟΪΟΝ ΠΟΥ ΕΠΙΣΤΡΕΦΕΤΑΙ ΣΤΗΝ EIZO Ή ΣΕ ΔΙΑΝΟΜΕΑ ΓΙΑ ΕΠΙΣΚΕΥΗ.**

**Η EIZO ΚΑΙ ΟΙ ΔΙΑΝΟΜΕΙΣ ΔΕΝ ΠΑΡΕΧΟΥΝ ΚΑΜΙΑ ΠΕΡΑΙΤΕΡΩ ΕΓΓΥΗΣΗ, ΡΗΤΗ Ή ΣΥΝΕΠΑΓΟΜΕΝΗ, ΟΣΟΝ ΑΦΟΡΑ ΤΟ ΠΡΟΪΟΝ ΚΑΙ ΤΗΝ ΠΟΙΟΤΗΤΑ, ΤΗΝ ΑΠΟΔΟΣΗ, ΤΗΝ ΕΜΠΟΡΕΥΣΙΜΟΤΗΤΑ Ή ΤΗΝ ΚΑΤΑΛΛΗΛΟΤΗΤΑ ΤΟΥ ΓΙΑ ΟΠΟΙΑΔΗΠΟΤΕ ΣΥΓΚΕΚΡΙΜΕΝΗ ΧΡΗΣΗ. ΣΕ ΚΑΜΙΑ ΠΕΡΙΠΤΩΣΗ Η EIZO Ή ΟΙ ΔΙΑΝΟΜΕΙΣ ΔΕΝ ΘΑ ΕΥΘΥΝΟΝΤΑΙ ΓΙΑ ΚΑΜΙΑ ΑΠΟΛΥΤΩΣ ΤΥΧΑΙΑ, ΕΜΜΕΣΗ, ΕΙΔΙΚΗ, ΣΥΝΕΠΑΓΟΜΕΝΗ Ή ΑΛΛΗ ΒΛΑΒΗ (ΠΕΡΙΛΑΜΒΑΝΟΜΕΝΩΝ, ΜΕΤΑΞΥ ΑΛΛΩΝ, ΒΛΑΒΩΝ Ή ΑΠΩΛΕΙΑΣ ΚΕΡΔΩΝ, ΔΙΑΚΟΠΗΣ ΕΠΙΧΕΙΡΗΜΑΤΙΚΩΝ ΔΡΑΣΤΗΡΙΟΤΗΤΩΝ, ΑΠΩΛΕΙΑΣ ΕΠΙΧΕΙΡΗΜΑΤΙΚΩΝ ΠΛΗΡΟΦΟΡΙΩΝ Ή ΤΥΧΟΝ ΑΛΛΗΣ ΧΡΗΜΑΤΙΚΗΣ ΑΠΩΛΕΙΑΣ) ΠΟΥ ΠΡΟΚΥΠΤΕΙ ΑΠΟ ΤΗ ΧΡΗΣΗ Ή ΤΗΝ ΑΝΙΚΑΝΟΤΗΤΑ ΧΡΗΣΗΣ ΤΟΥ ΠΡΟΪΟΝΤΟΣ Ή ΤΥΧΟΝ ΑΛΛΗΣ ΣΥΝΔΕΣΗΣ ΜΕ ΤΟ ΠΡΟΪΟΝ, ΕΙΤΕ ΒΑΣΙΖΕΤΑΙ ΣΕ ΣΥΜΒΟΛΑΙΟ, ΒΛΑΒΗ, ΑΜΕΛΕΙΑ, ΑΥΣΤΗΡΗ ΕΥΘΥΝΗ Ή ΕΙΔΑΛΛΩΣ, ΑΚΟΜΗ ΚΙ ΕΑΝ Η EIZO Ή ΟΙ ΔΙΑΝΟΜΕΙΣ ΕΝΗΜΕΡΩΘΟΥΝ ΓΙΑ ΤΗΝ ΠΙΘΑΝΟΤΗΤΑ ΤΕΤΟΙΩΝ ΖΗΜΙΩΝ. Η ΕΞΑΙΡΕΣΗ ΑΥΤΗ ΠΕΡΙΛΑΜΒΑΝΕΙ ΕΠΙΣΗΣ ΟΠΟΙΑΔΗΠΟΤΕ ΕΥΘΥΝΗ ΕΝΔΕΧΕΤΑΙ ΝΑ ΠΡΟΚΥΨΕΙ ΑΠΟ ΑΞΙΩΣΕΙΣ ΤΡΙΤΟΥ ΜΕΡΟΥΣ ΚΑΤΑ ΤΟΥ ΑΡΧΙΚΟΥ ΑΓΟΡΑΣΤΗ. Η ΟΥΣΙΑ ΤΟΥ ΟΡΟΥ ΑΥΤΟΥ ΕΙΝΑΙ ΝΑ ΠΕΡΙΟΡΙΣΕΙ ΤΗΝ ΠΙΘΑΝΗ ΕΥΘΥΝΗ ΤΗΣ EIZO ΚΑΙ ΤΩΝ ΔΙΑΝΟΜΕΩΝ ΠΟΥ ΠΡΟΚΥΠΤΕΙ ΑΠΟ ΤΗΝ ΠΑΡΟΥΣΑ ΕΓΓΥΗΣΗ Ή/ΚΑΙ ΤΙΣ ΠΩΛΗΣΕΙΣ.**

## ОГРАНИЧЕННАЯ ГАРАНТИЯ

EIZO Corporation (называемая в дальнейшем “EIZO”) и авторизованные EIZO дистрибуторы (называемые в дальнейшем “Дистрибуторы”) гарантируют, в соответствии с условиями и пунктами этой ограниченной гарантии (называемой в дальнейшем “Гарантия”), первичному покупателю (называемому в дальнейшем “Первоначальный покупатель”), который приобрел у EIZO или Дистрибуторов продукт, указанный в этом документе (называемый в дальнейшем “Продукт”), что EIZO или Дистрибуторы на свое усмотрение либо бесплатно отремонтируют, либо бесплатно заменят Продукт, если Первоначальный покупатель признает в пределах Гарантийного срока (определенного ниже), что Продукт неисправен или он поврежден процессе нормального использования продукта в соответствии с описанием в инструкции по эксплуатации, прилагаемой к Продукту (называемой в дальнейшем “Руководство пользователя”).

Гарантийный период ограничен сроком три (3) года от даты приобретения Продукта (называемый в дальнейшем “Гарантийный период”). EIZO и Дистрибуторы не несут никакой ответственности и не берут обязательств относительно Продукта по отношению к Первоначальному покупателю или по отношению к любым третьим сторонам, кроме обязательств, оговоренных в этой Гарантии.

EIZO и Дистрибуторы прекратят хранение или складирование любых деталей Продукта по истечении семи (7) лет после прекращения производства таких деталей. В случае ремонта монитора EIZO и Дистрибуторы будут использовать запчасти, которые соответствуют нашим стандартам QC (контроль качества).

Гарантия действительна только в странах или регионах, где расположены Дистрибуторы. Гарантия не ограничивает никакие законные права Первоначального покупателя.

Несмотря на другие условия этой Гарантии EIZO и Дистрибуторы не несут никаких обязательств согласно этой Гарантии в любом из перечисленных ниже случаев:

- (а) Любые дефекты Продукта, вызванные повреждениями при перевозке, модификацией, изменением, неправильным обращением, неправильным использованием, авариями, неправильной установкой, стихийными бедствиями, неправильным уходом и/или неправильным ремонтом третьей стороной, отличной от EIZO или Дистрибуторов;
- (б) Любые несовместимости Продукта из-за технических усовершенствований и/или изменения технических норм;
- (в) Любое повреждение датчика;
- (г) Любые ухудшения работы дисплея, вызванные изнашиванием невосстановимых частей, таких как панель ЖКД и/или подсветка и т.д. (например, изменение в яркости, изменение в равномерности яркости, изменение в цветности, изменение в равномерности цветности, изменение в пикселях, включая выгоревшие пиксели и т.д.);
- (д) Любые дефекты Продукта, вызванные внешним оборудованием;
- (е) Любые дефекты Продукта, при которых оригинальный серийный номер был изменен или удален;
- (ж) Любые дефекты Продукта, вызванные протеканием батареек;
- (з) Любые естественные ухудшения продукта, в частности, вызванные износом расходных частей, принадлежностей и/или приспособлений (например, батареек, кнопок, вращающихся частей, пульта дистанционного управления, кабелей, Руководства пользователя и т.д.); и
- (и) Любые деформации, изменения цвета и/или коробления внешней поверхности продукта, включая поверхность панели ЖКД.

Чтобы получить техническое обслуживание в рамках Гарантии, Первоначальный покупатель должен доставить Продукт местному Дистрибутору, оплатив перевозку, в его оригинальной упаковке или в другой соответствующей упаковке, обеспечивающей равноценную степень защиты, принимая во внимание риск повреждения и/или утери при транспортировке. При запросе технического обслуживания в рамках Гарантии Первоначальный покупатель должен предоставить свидетельство покупки продукта и даты покупки.

Гарантийный период для любого замененного и/или отремонтированного продукта в рамках Гарантии истекает в конце завершения срока действия оригинального Гарантийного периода.

**EIZO ИЛИ ДИСТРИБУТОРЫ НЕ НЕСУТ ОТВЕТСТВЕННОСТИ ЗА ЛЮБЫЕ ПОВРЕЖДЕНИЯ ИЛИ УТЕРЮ ДАННЫХ ИЛИ ДРУГОЙ ИНФОРМАЦИИ, ХРАНЯЩИХСЯ НА КАКИХ-ЛИБО НОСИТЕЛЯХ ИНФОРМАЦИИ ИЛИ НА ЛЮБЫХ ДРУГИХ ЧАСТЯХ ПРОДУКТА, КОТОРЫЙ ВОЗВРАЩЕН EIZO ИЛИ ДИСТРИБУТОРАМ ДЛЯ РЕМОНТА.**

EIZO и ДИСТРИБУТОРЫ НЕ ДАЮТ НИКАКОЙ ДАЛЬНЕЙШЕЙ ГАРАНТИИ, ВЫРАЖЕННОЙ ИЛИ ПОДРАЗУМЕВАЕМОЙ, ОТНОСИТЕЛЬНО ПРОДУКТА И ЕГО КАЧЕСТВА, ТЕХНИЧЕСКИХ ХАРАКТЕРИСТИК, ТОВАРНОСТИ ИЛИ СООТВЕТСТВИЯ ДЛЯ КАКОГО-ЛИБО ОПРЕДЕЛЕННОГО ИСПОЛЬЗОВАНИЯ. НИ ПРИ КАКИХ УСЛОВИЯХ EIZO ИЛИ ДИСТРИБУТОРЫ НЕ НЕСУТ ОТВЕТСТВЕННОСТИ ЗА ЛЮБОЙ СЛУЧАЙНЫЙ, КОСВЕННЫЙ, СПЕЦИАЛЬНЫЙ, ПОБОЧНЫЙ ИЛИ ИНОЙ УЩЕРБ (ВКЛЮЧАЯ, БЕЗ ОГРАНИЧЕНИЙ, УЩЕРБ ИЗ-ЗА НЕПОЛУЧЕННОЙ ПРИБЫЛИ, ПРЕРЫВАНИЯ БИЗНЕСА, ПОТЕРИ КОММЕРЧЕСКОЙ ИНФОРМАЦИИ ИЛИ ЛЮБЫЕ ДРУГИЕ ФИНАНСОВЫЕ ПОТЕРИ), ВОЗНИКШИЙ ИЗ-ЗА ИСПОЛЬЗОВАНИЯ ИЛИ НЕВОЗМОЖНОСТИ ИСПОЛЬЗОВАТЬ ПРОДУКТ ИЛИ В ЛЮБОЙ ДРУГОЙ СВЯЗИ С ПРОДУКТОМ, ЛИБО ОСНОВАННЫЙ НА КОНТРАКТНЫХ ОТНОШЕНИЯХ, ГРАЖДАНСКИХ ПРАВОНАРУШЕНИЯХ, НЕБРЕЖНОСТИ, ПРИЧИНЕНИЯ УЩЕРБА ТРЕТЬЕЙ СТОРОНЕ ИЛИ ЧЕМ-ЛИБО ЕЩЕ, ДАЖЕ ЕСЛИ EIZO ИЛИ ДИСТРИБУТОРЫ БЫЛИ УВЕДОМЛЕННЫ О ВОЗМОЖНОСТИ ТАКОГО УЩЕРБА. ЭТО ИСКЛЮЧЕНИЕ ТАКЖЕ ВКЛЮЧАЕТ ЛЮБЫЕ ОБЯЗАТЕЛЬСТВА, КОТОРЫЕ МОГУТ ВОЗНИКНУТЬ В РЕЗУЛЬТАТЕ ТРЕБОВАНИЙ ТРЕТЬЕЙ СТОРОНЫ В ОТНОШЕНИИ ПЕРВОНАЧАЛЬНОГО ПОКУПАТЕЛЯ. СУЩЕСТВОМ ЭТОГО ПОЛОЖЕНИЯ ЯВЛЯЕТСЯ ОГРАНИЧЕНИЕ ПОТЕНЦИАЛЬНОЙ ОТВЕТСТВЕННОСТИ EIZO И ДИСТРИБУТОРОВ, ВОЗНИКАЮЩЕЙ ИЗ-ЗА ЭТОЙ ОГРАНИЧЕННОЙ ГАРАНТИИ И/ЛИ ПРОДАЖ.

## 有限责任保证书

EIZO Corporation (以下简称“EIZO”)和EIZO授权的经销商(以下简称“经销商”),接受并依照本有限责任保证书(以下简称“保证书”)之条款,向从EIZO和经销商购买本文中规定产品(以下简称“产品”)的原买方(以下称“原买方”)提供保证:在保证期内(规定如下),如果原买方发现按本产品所附使用说明书(以下简称“用户手册”)所述方式正常使用本产品过程中,本产品出现故障或损坏,EIZO和经销商根据其独立的判断免费修理或更换该产品。

本保证期限定为本产品自购买本产品之日起的三(3)年(以下简称“保证期限”)。EIZO和经销商将不向原买方或任何第三方承担本保证书所规定之外的与本产品有关任何责任或义务。

本产品的任何部件停产七(7)年后,EIZO和经销商将不再保留或保管任何这类部件。维修显示器时,EIZO与经销商将使用符合我方质量控制标准的替换零件。

本保证书仅对于设有经销商的国家或地区有效。本保证书并不限定原买方的任何法律权利。

无论本保证书的任何其他条款如何规定,对于任何下列情况之一,EIZO和经销商将不承担本保证书规定责任:

- (a) 由于运输损害、改装、改动、滥用、误用、意外事故、错误安装、灾害、维护不善和/或由除EIZO和经销商以外的第三方进行不适当的修理造成本产品的任何故障。
- (b) 由于可能发生的技术变更和/或调整造成本产品的任何不兼容性。
- (c) 传感器的任何劣化。
- (d) 由于诸如液晶显示屏(LCD)和/或背灯等消耗品部件的老化造成的任何显示性能低劣(如亮度变化、亮度均一性变化、色彩变化、色彩均一性变化、如烧伤像素等像素缺陷)。
- (e) 因外部设备造成本产品的任何故障。
- (f) 因本产品的原序号被改变或消除造成本产品的任何故障。
- (g) 因电池液体泄漏造成本产品的任何故障。
- (h) 本产品的任何正常老化,尤其是消耗品、附件和/或附加装置(如电池、按钮、旋转部件、遥控器、电缆、用户手册等)、以及
- (i) 本产品表面包括液晶显示屏(LCD)表面的任何变形、变色和/或翘曲。

为了获得本保证书规定的服务,原买方必须使用原包装或其他具有同等保护程度的适当包装将本产品运送到当地的经销商,并且预付运费,承担运输中的损坏和/或损失的风险。要求提供本保证书规定的服务时,原买方必须提交购买本产品和标明此购买日期的证明。

按本保证书规定进行了更换和/或修理的任何产品的保证期限,将在原保证期限结束时终止。

在返回给EIZO和经销商进行修理后,任何产品的任何媒体或任何部件中储存的数据或其他信息发生任何损坏或损失,对此EIZO和经销商将不承担责任。

对于本产品及其质量、性能、可销售性以及对于特殊用途的适合性,EIZO和经销商不提供其他任何明示或暗示的保证。因使用本产品或无法使用本产品或因与本产品有任何关系(无论是否根据合同)而造成:任何附带的、间接的、特殊的、随之发生的或其他的损害(包括但不限于利润损失、业务中断、业务信息丢失或其他任何金钱损失)以及侵权行为、过失、严格赔偿责任或其他责任,即使已经向EIZO和经销商提出了发生这些损害的可能性,对此EIZO和经销商概不承担责任。本免责条款还包括因第三方向原买方提出索赔而可能发生的任何责任。本条款的本质是限定由于本有限责任保证书和/或销售本产品所发生的EIZO和经销商的潜在责任。



# China Measures for RoHS Compliance in ChinaRoHS

## 关于电子信息产品污染控制标识



本标识根据「电子信息产品污染控制管理办法」，适用于在中华人民共和国销售的电子信息产品。标识中央的数字为环保使用期限的年数。只要您遵守该产品相关的安全及使用注意事项，在自制造日起算的年限内，不会产生对环境污染或人体及财产的影响。上述标识粘贴在机器背面。

### • 有毒有害物质或元素的名称及含量

部件名称	有毒有害物质或元素					
	铅 (Pb)	汞 (Hg)	镉 (Cd)	六价铬 (Cr (VI))	多溴联苯 (PBB)	多溴二苯醚 (PBDE)
印刷电路板	×	○	○	○	○	○
机箱	○	○	○	○	○	○
液晶显示器	×	○	○	○	○	○
其他	×	○	○	○	○	○

○：表示该有毒有害物质在该部件所有均质材料中的含量均在 SJ/T 11363-2006 规定的限量要求以下。  
 ×：表示该有毒有害物质至少在该部件的某一均质材料中的含量超出 SJ/T 11363-2006 规定的限量要求。  
 （企业可在此处，根据实际情况对上表中打“×”的技术原因进行进一步说明）

