

LED Installation Manual

Version: V03

Data : 02-Jun-2020

Pitch
6.7mm
Model name
XA067T

Pitch
10mm
Model name
XA100T

Pitch
16mm
Model name
XA160T

Table of contents

	Title	Page
0	Installation process	<u>3</u>
1	Product information	<u>4</u>
2	Preparation and precautions for installation	<u>14</u>
3	Installation Specification	<u>18</u>
4	Steel structure installation	<u>19</u>
5	Set installation	<u>27</u>
6	Difference adjustment on set	<u>35</u>
7	Sending box connection	<u>39</u>
8	Power and signal connection	<u>41</u>
9	Module replacement	<u>45</u>
10	Software setting	<u>47</u>
Appendix 1	Product accessories	<u>50</u>

0. Installation process

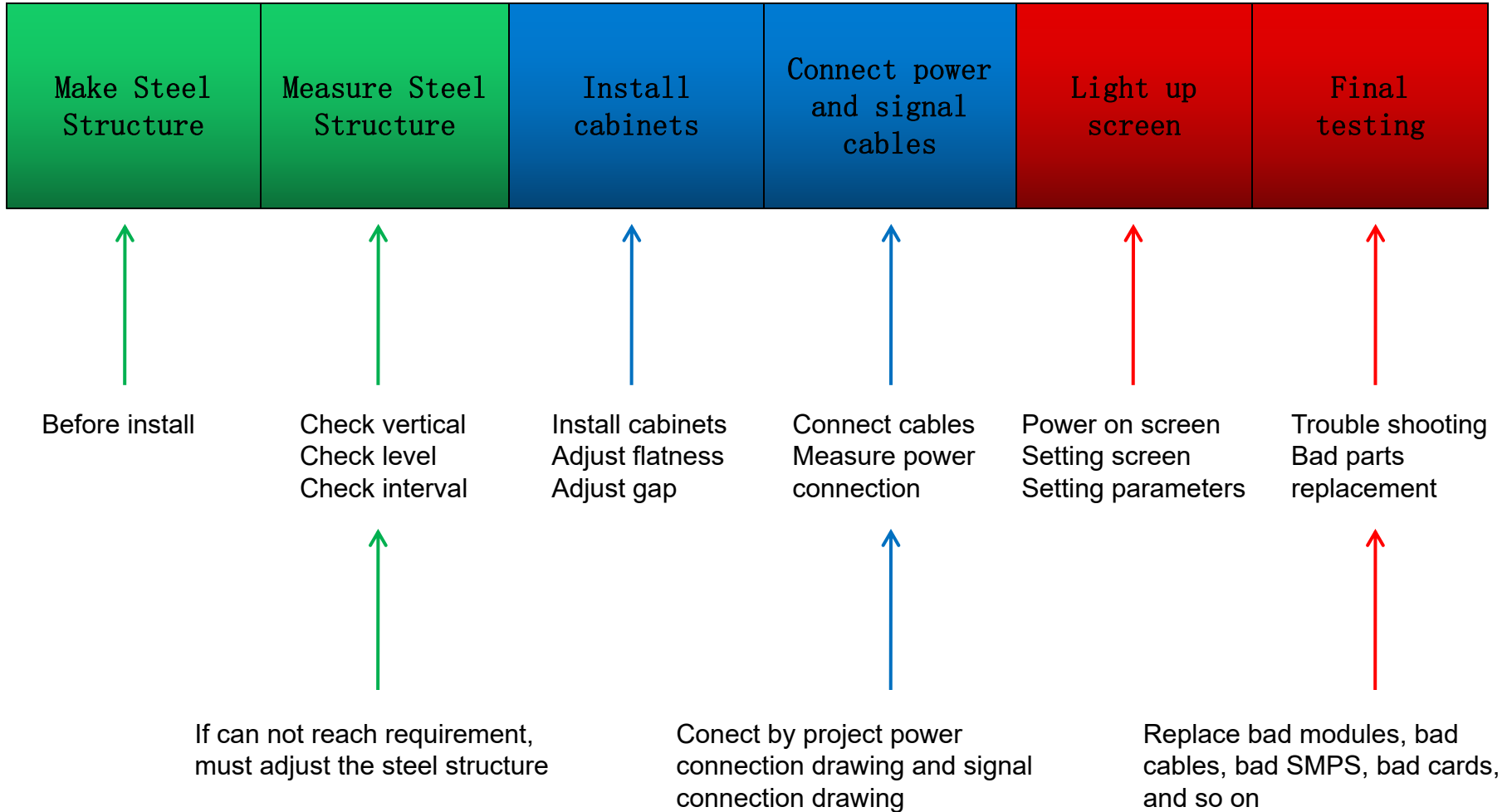

1. Product information

Screen size(Including the cabinets)



For example: P10, 960mm*960mm, 6(H)*4(V)

1. Product information

Set:
-Outside



Bottom

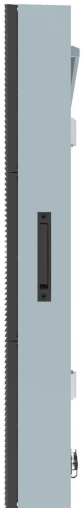

Right

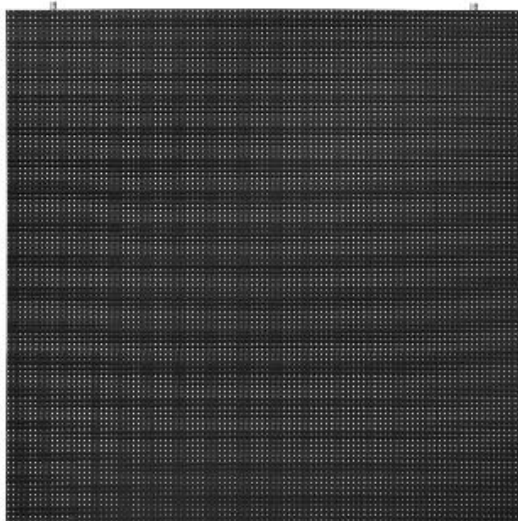

Front



Left



Back



Top

1. Product information

Set:

- Outside
- Size(side view, front view) XAT6.7/10

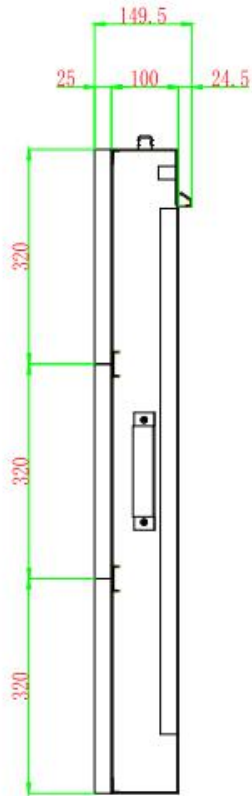

Right Side

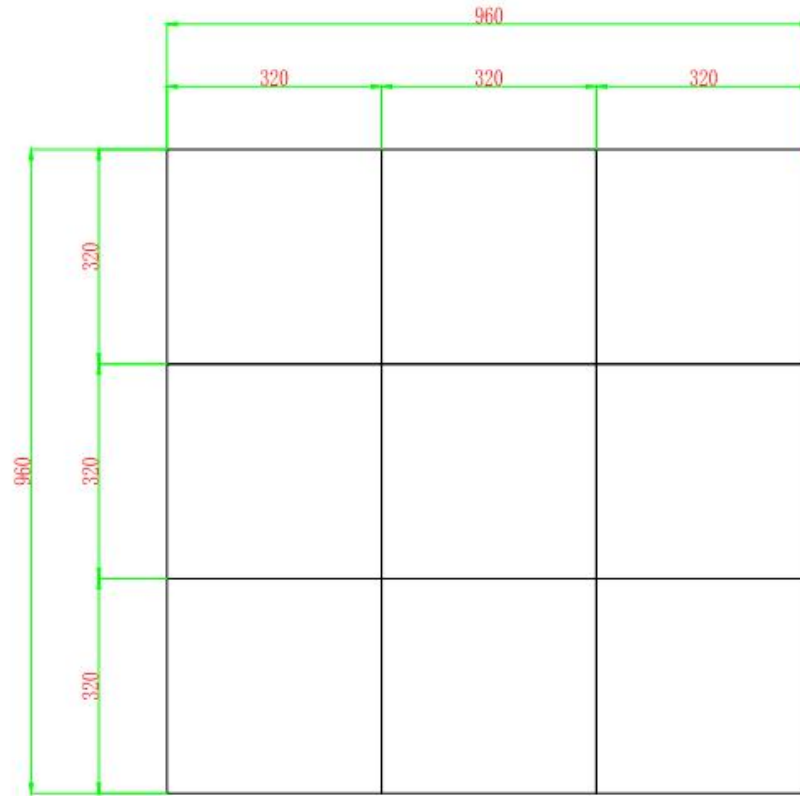

Front View

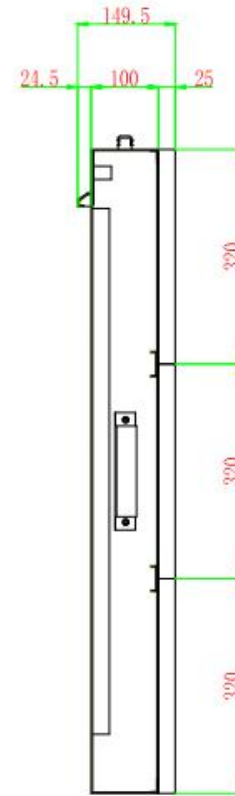

Left Side

1. Product information

Set:

- Outside
- Size(side view, front view) XAT16

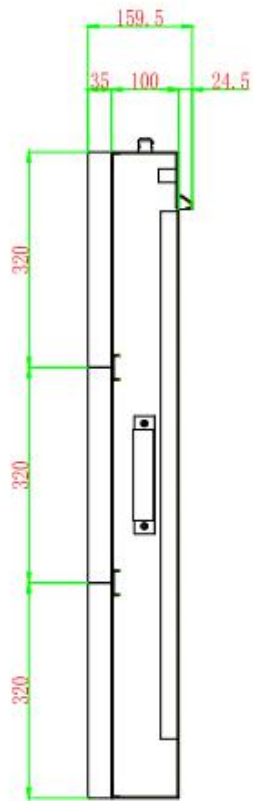

Right Side

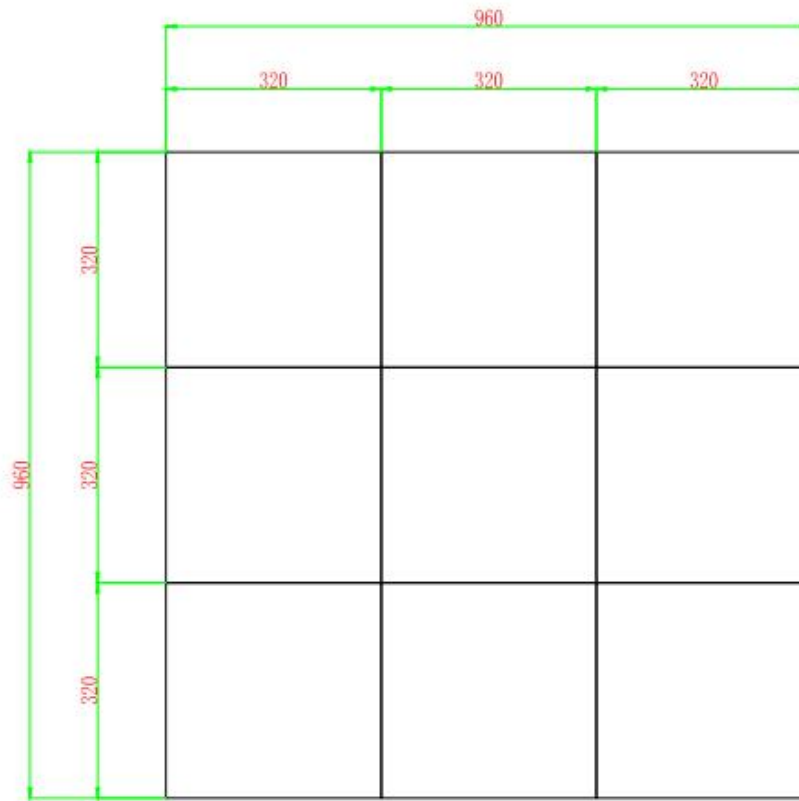

Front View

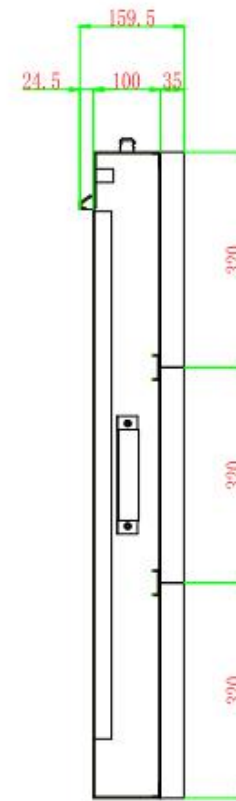

Left Side

1. Product information

Set:

-Outside

-Size tolerance -0.5~-1mm(back view) XAT6.7/XAT10

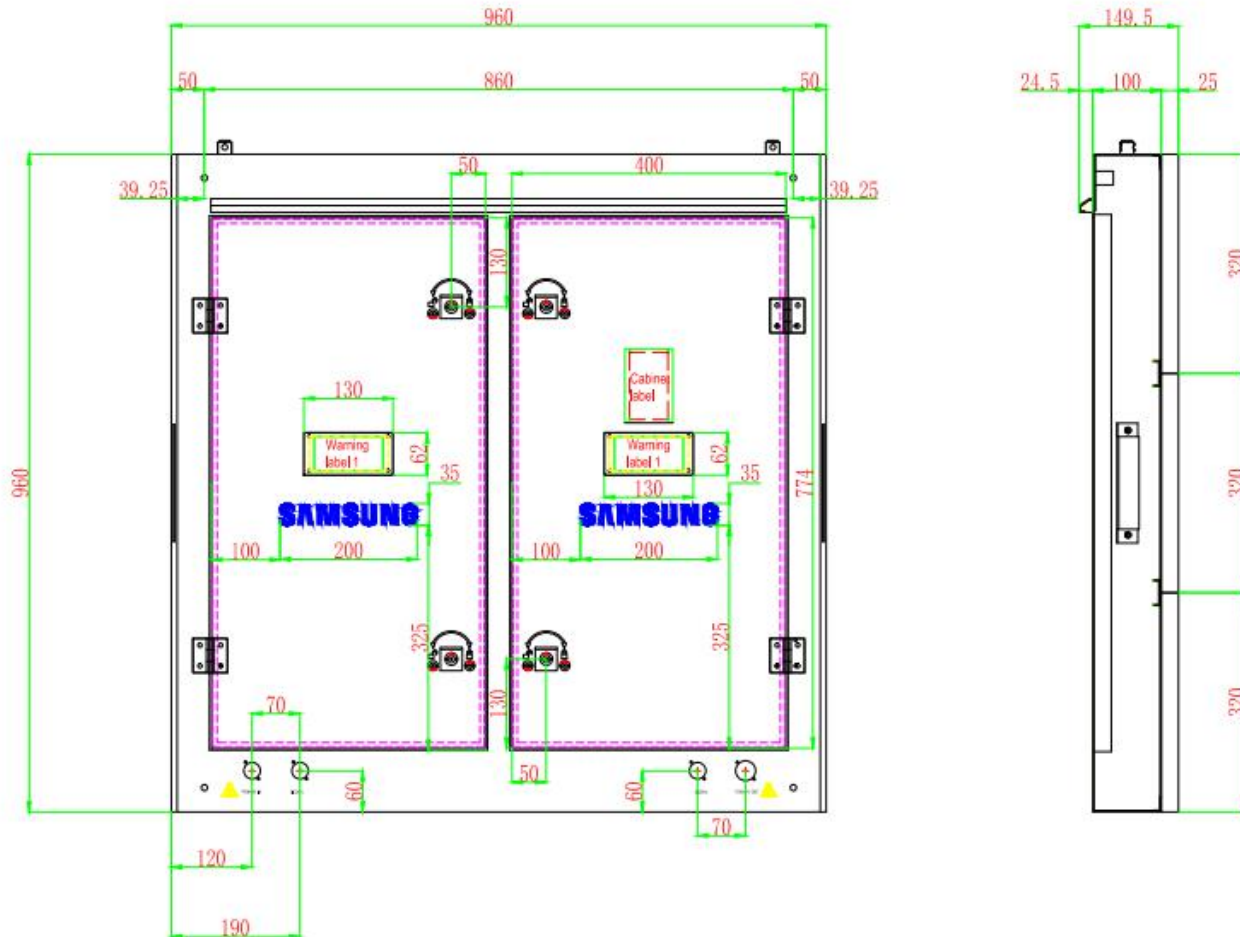

1. Product information

Set:

- Outside
- Size tolerance -0.5~-1mm(back view) XAT16

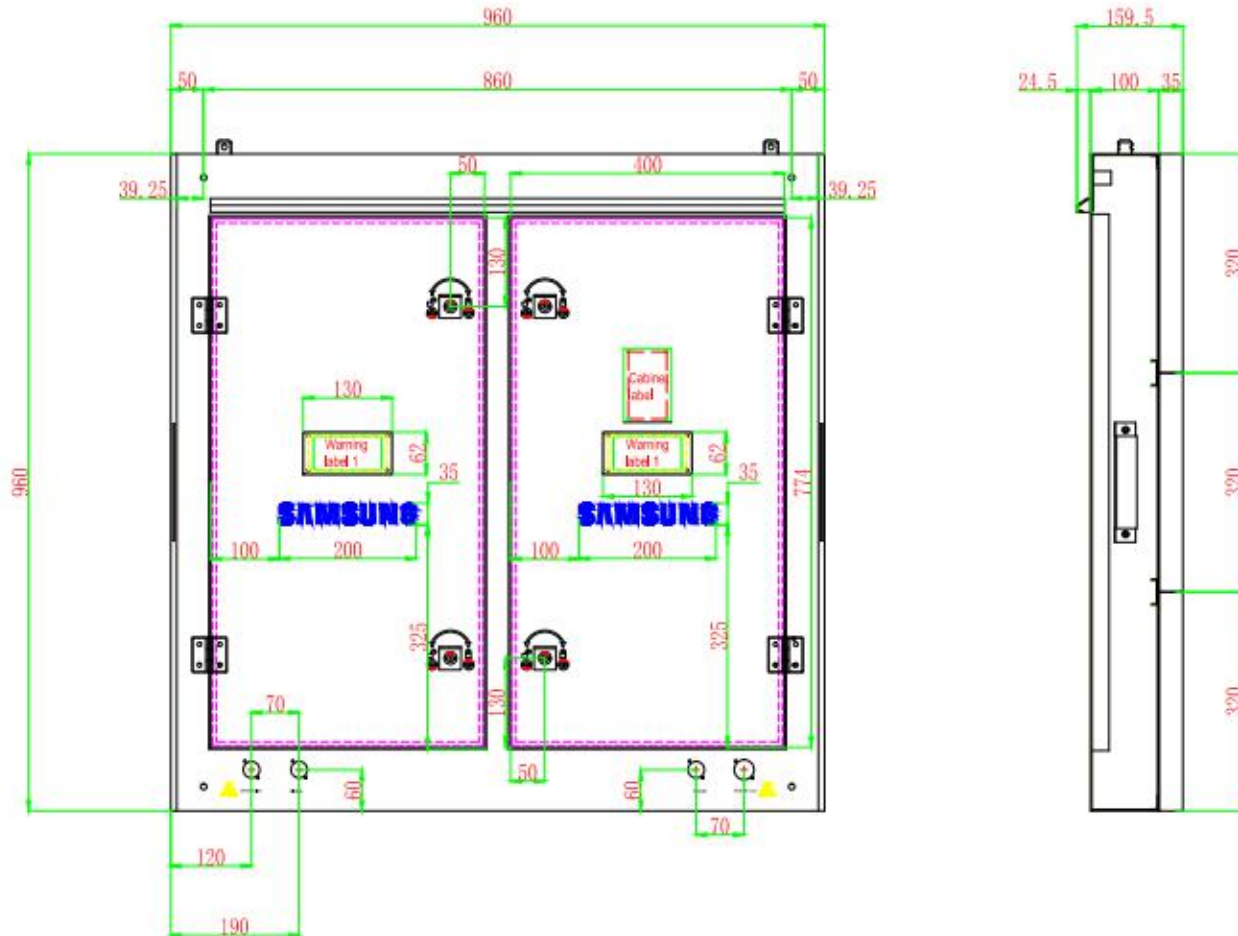

1. Product information

Set:
-Inside

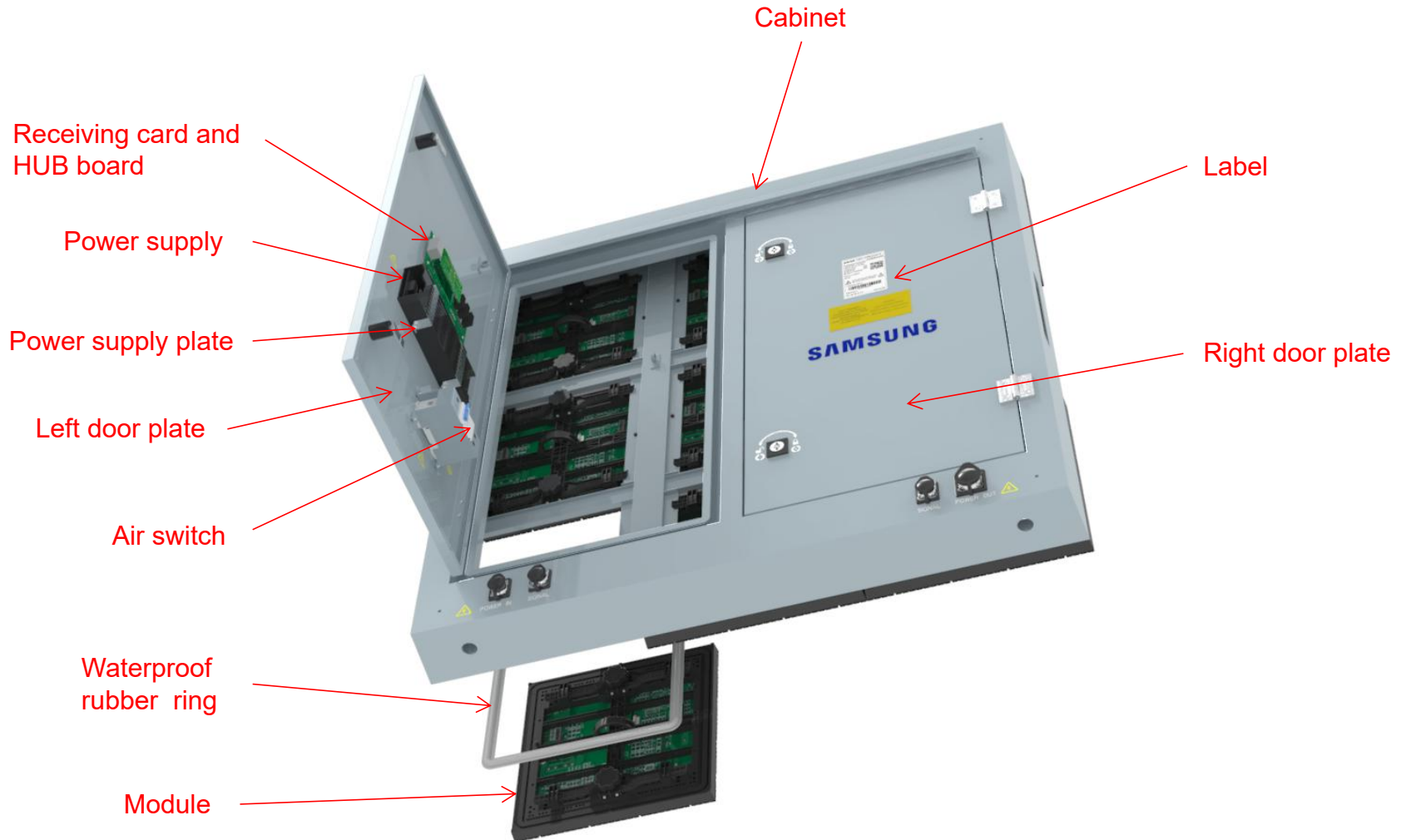

1. Product information

Set:

- Module configuration with in a set
- Module X 9

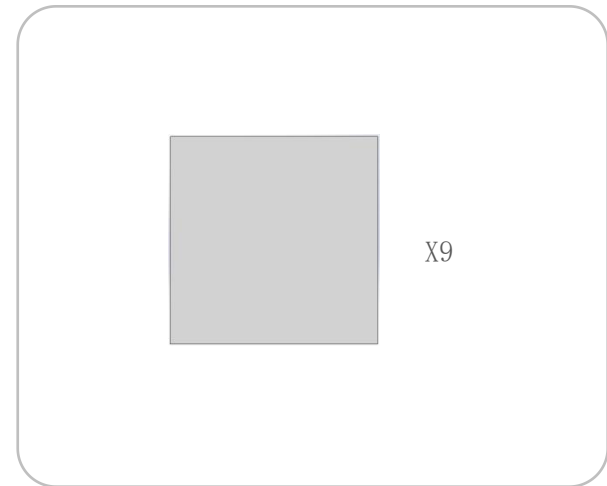
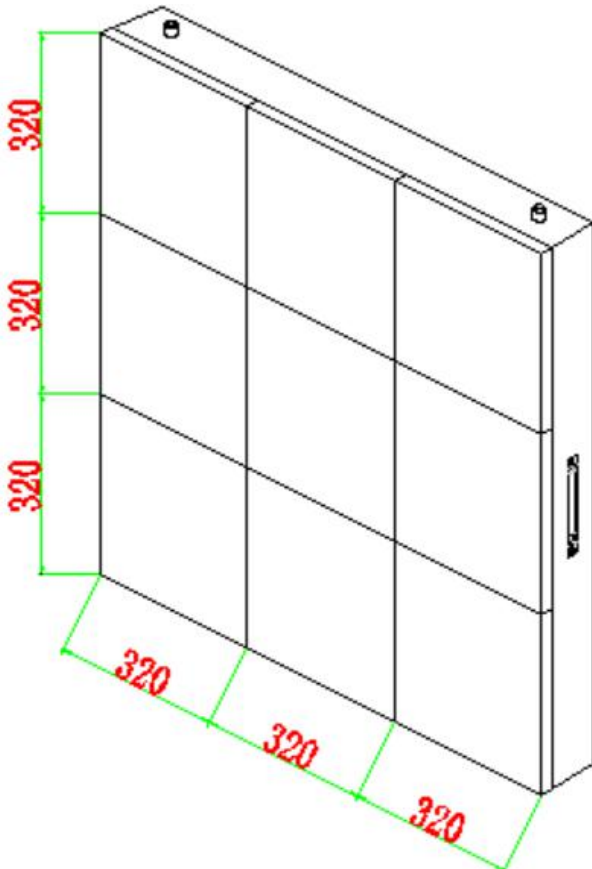

1. Product information

Set:

-Design for preventing module from falling

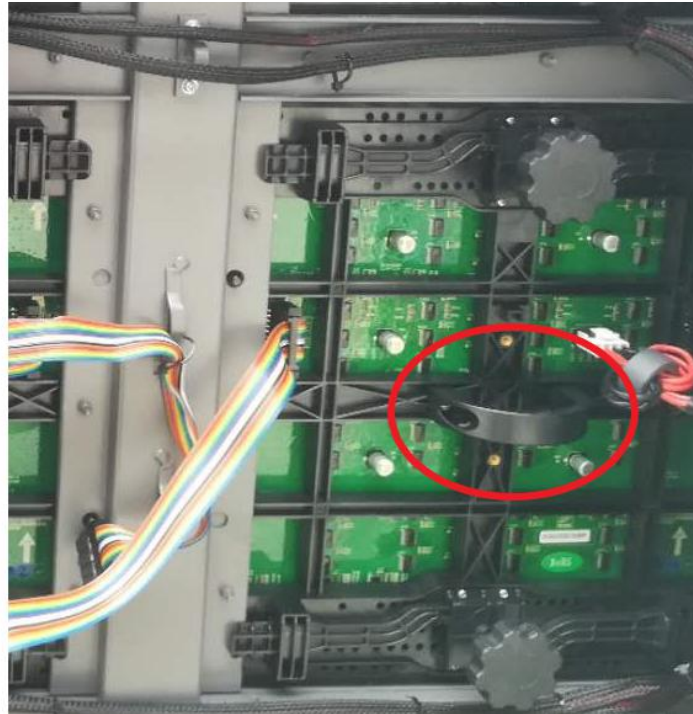

Handlebar on the module to prevent module from falling, people can hold it when do service for LED screen

1. Product information

Set:

-Label instruction



ETL High voltage warning label



ETL Matters needing attention label



Product security label

2. Preparations and precautions for installation

Preparation for handling

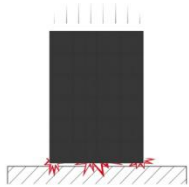

[Be careful of external damage and drop]

Be careful not to apply damage or vibration on the product or not to drop it after removing the protective bracket.



[Be careful of damage on LED]

Be careful not to apply damage or vibration while the product is laid down.

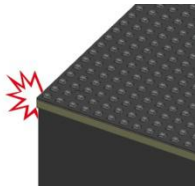

[Be careful of damage on edges]

In particular, be careful not to damage edges of the set.



[Be careful of damage on LED]

Do not place the LED surface facing the floor after removing the protective bracket.



[Be careful of damage on LED due to electric shock]

Do not touch the product while not wearing anti-static gloves.

2. Preparations and precautions for installation

Preparation before installation

-Tools (Prepared by the SI company or the Customer)



Horizontal instrument



Digital level



Measuring tape



Welder



Cutter



Socket wrench



+Screwdriver



Multimeter



-Screwdriver



Network wire tester



Vertical line meter



Metal gasket

2. Preparations and precautions for installation

Preparation before installation

-Safety Guidelines

Personal protection

Ensure you understand and follow all the safety guidelines, installation instruction, warnings and symbols.

Mind yourself while working with heavy loads and high voltage.

Contact with high voltage may cause death or serious injury. Always disconnect power to the display cabinet or cabinets prior to servicing.

All personnel at the LED Video Board installation site are required to have personal protection equipment (PPE) such as hard hats, safety glasses, gloves, harnesses, and other appropriate safety equipment.

Equipment protection

This installation must be performed by authorized and qualified technical personnel only.

Accredited safety officers must ensure the safety of the site, construction, assembly, connection, use, dismantling, transport etc.

Assembly parts are designed for use only with Samsung displays.

LEDs use specific materials and manufacturing processing in order to achieve unique advantages. Do not modify and/or replicate any components.

Ground the LED display screen before connecting the power source. Contacting displays that are not earth-grounded may cause death or serious injury.

Do not use the LED display screen ground lugs for installation equipment such as welding equipment.

Structural & mounting components should be kept dry, clean, lubricated (only if recommended), coated properly, and maintained in a manner consistent with part design. LED products must be installed and operated in a manner to rely on its design and inspection a routine basis for security, wear, deformation, corrosion and any other circumstances that may affect the load handling capability of the part.

We recommend inspections at regular intervals for all installations and increasing in frequency for more critical installations. A part is damaged which may cause a decrease in load capability. The part must be removed for service or replaced immediately. Always follow LED display screen installation instruction.

Contact the support technical person if user has any question regarding the safety of an application. The manufacturer assumes no liability for incorrect, inadequate, irresponsible or unsafe assembly of systems.

2. Preparations and precautions for installation

Preparation before installation

-Installation instructions

Instructions

Read these instructions.

Keep these instructions.

Heed all warnings.

Follow all instructions.

Do not block ventilation openings. Please install in accordance with the manufactures instructions.

Avoid installation near heat sources such as radiators, heat registers, stoves, or other apparatus (including amplifiers) that produce heat. We suggest the user install some equipment to reduce the heat if any.

Do not break the safety purpose of polarized or grounding type plugs/sockets. If the provided sockets/plugs are damaged then replacement of the detective parts must be undertaken immediately.

Protect the power/data cords from being taken off or pinched particularly at plugs, convenience receptacles, and the point where they exit from the apparatus. Replace damaged power/data cords immediately.

Only use attachments/accessories specified or provided by the manufacturer.

Use with caution during lifting/moving or transporting to avoid damage by possible crash. After receiving the LED display screen, please uncover all the boxes and cases, count and check all things compare with the packing list. If there is any problem such as missing or damaged part, contact the manufacture immediately.

Installation guide details are shown in charter 7&8.

3. Installation Specification

Installation Specification

- Installation Specification for XAT product

Specification		XAT6.67	XAT10	XAT16
110V	Current of per cabinet	7A	7A	5.4A
	Power chain for per input	2 PCS	2 PCS	3 PCS
220V	Current of per cabinet	3.5A	3.5A	2.7A
	Power chain for per input	5 PCS	5 PCS	6 PCS
Singal chain for per port		30 PCS	60 PCS	160 PCS
Weight of per cabinet (Kg)		32	32	37
Heat Power Consumption per Cabinets (BTU)		1564	1535	518
Required Air Flow (CFM)		76	74.73	25
Space for Front service (Behind cabinet)		25cm	25cm	25cm
Space for Back service (Behind cabinet)		60cm	60cm	60cm

4. Steel structure installation

Preparation before installation

-Installation Steel Structure sample

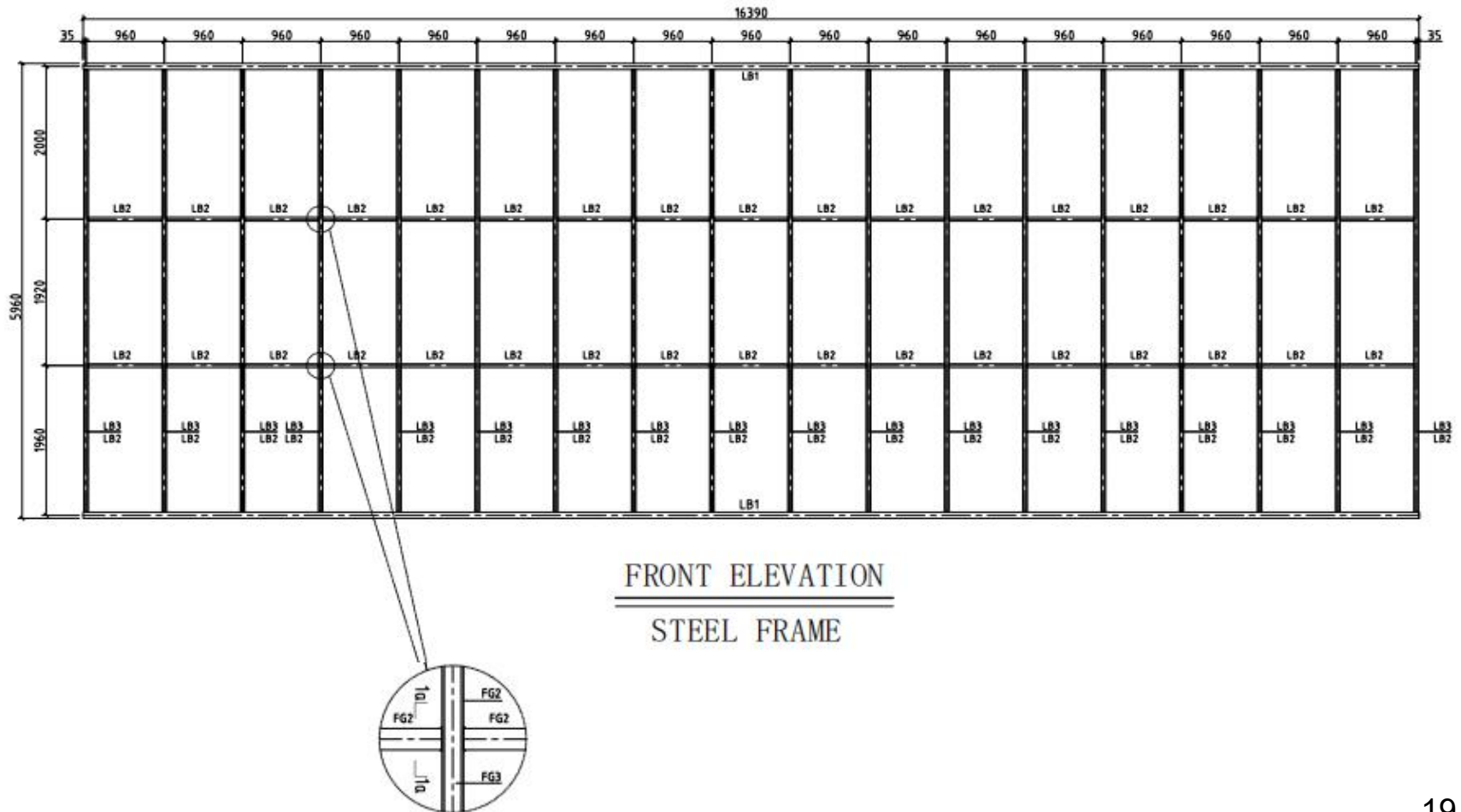

4. Steel structure installation

Preparation before installation

- Installation Steel Structure sample
- Connection between cabinets and steel structure

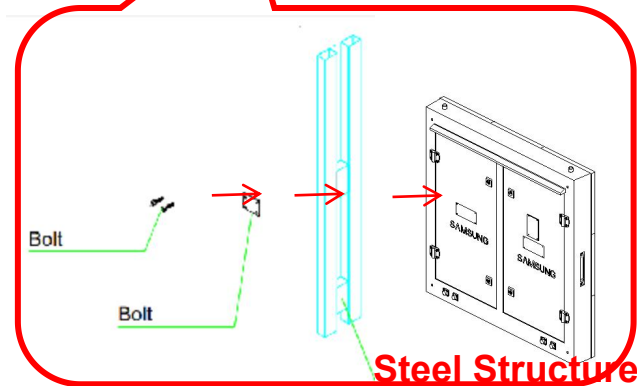
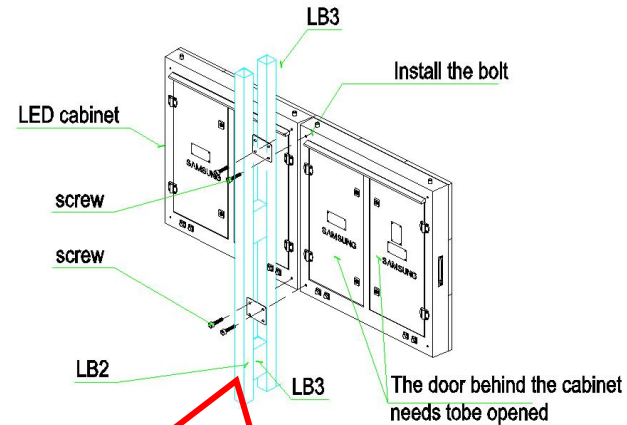
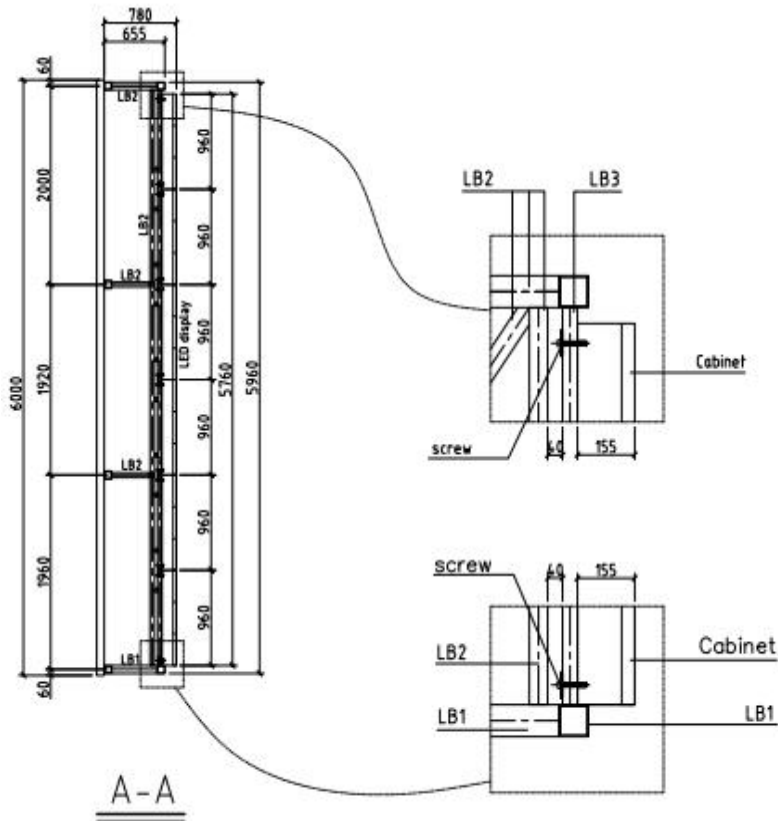

Do not weld the connecting plates on the steel structure

4. Steel structure installation

Preparation before installation

- Installation Steel Structure sample
- Service path, lighting inside, cooling system and so on.

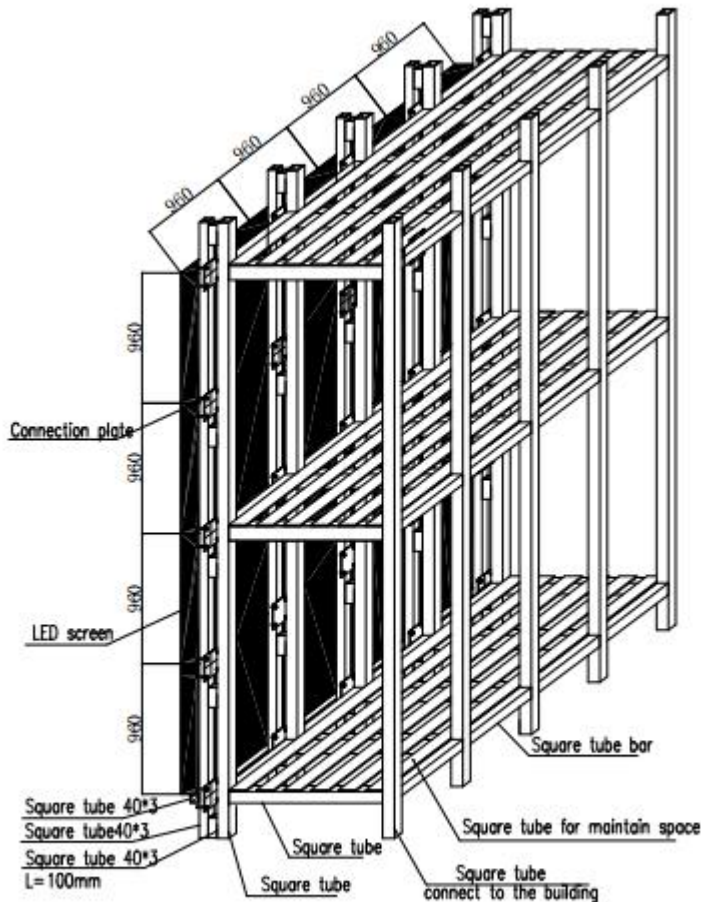

Guide to install Retop screen for steel structure

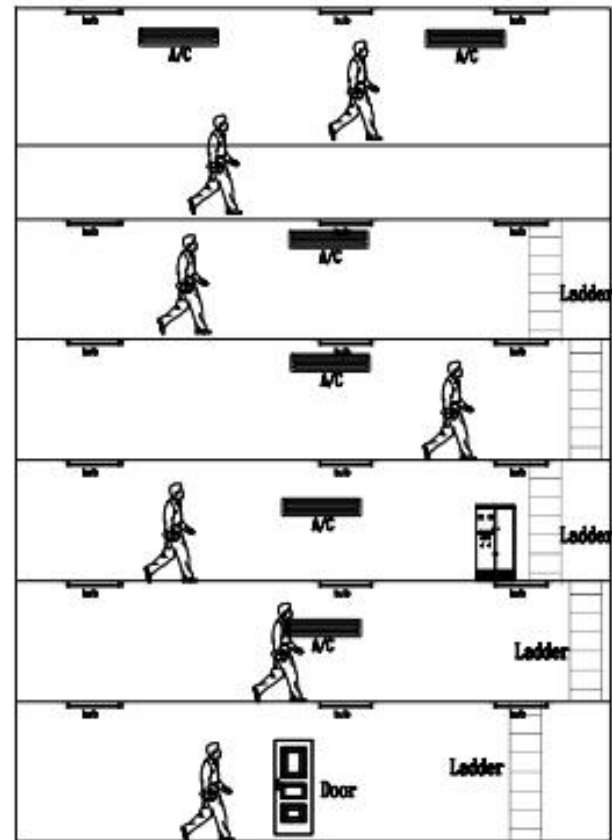

INSIDE CONSTRUCTION SCHEMATIC DRAWING

4. Steel structure installation

Preparation before installation

- Space between cabinet and steel structure

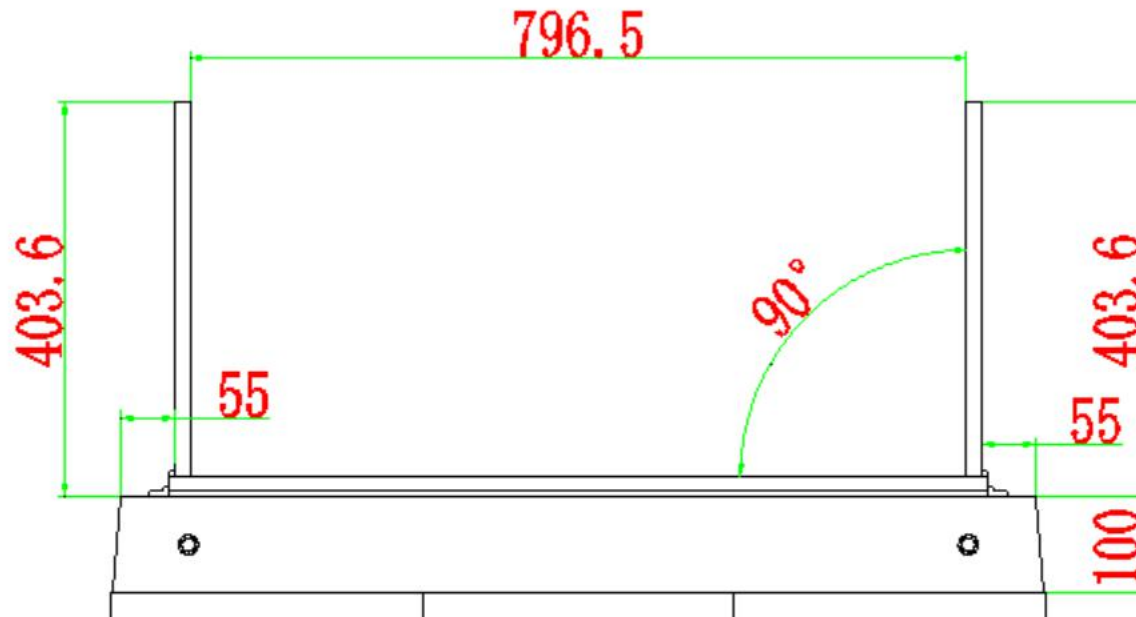

For back service, the back door must can be opened ,so the space between cabinet and steel structure should more than 600mm.

4. Steel structure installation

Preparation before installation

-Measure Steel structure (Vertical line)

Use the vertical line meter to measure that if the vertical bar is completely vertical.

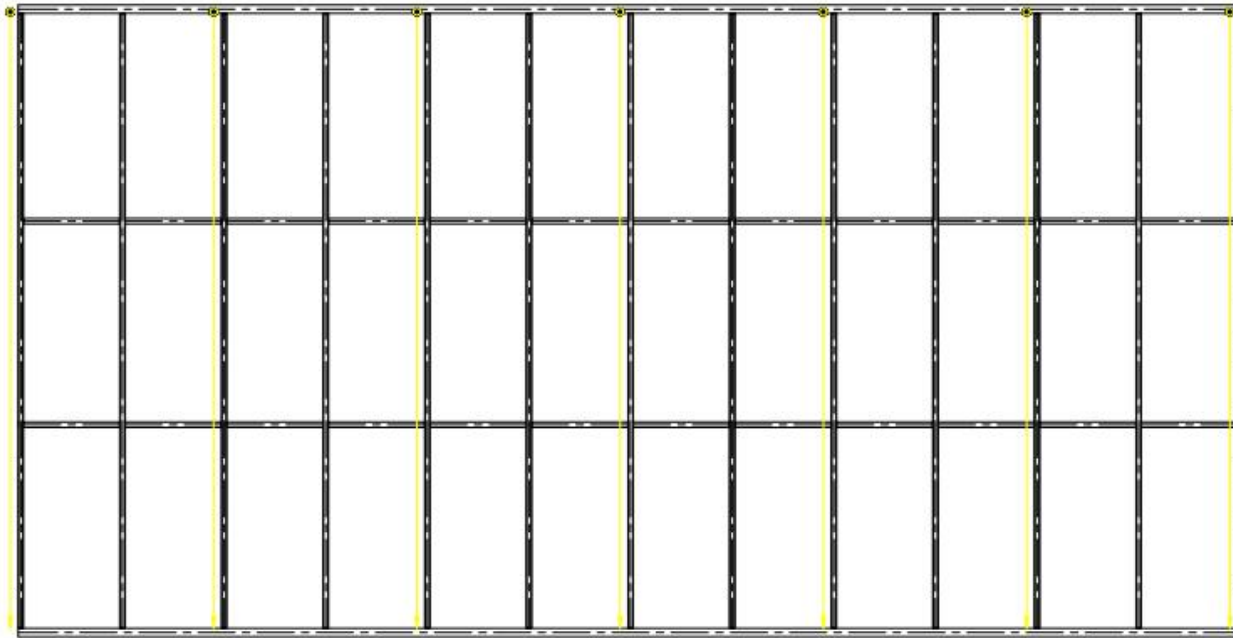

4. Steel structure installation

Preparation before installation

-Measure Steel structure (Horizontal line)

Use the Horizontal instrument to measure that if the horizontal beam is completely horizontal



The distance between the horizontal bar and the light line which is sent out by the horizontal meter must be same (The tolerance is 2mm)

4. Steel structure installation

Preparation before installation

-Measure the space between vertical bar

Use the measure tape to measure the space between vertical bars

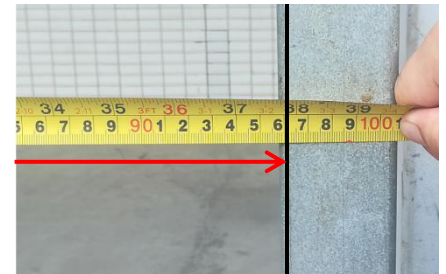
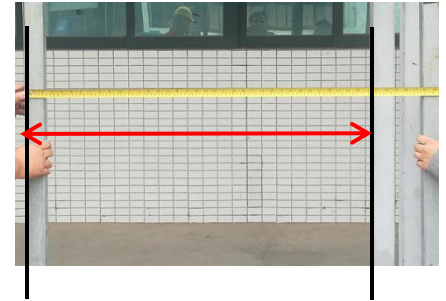
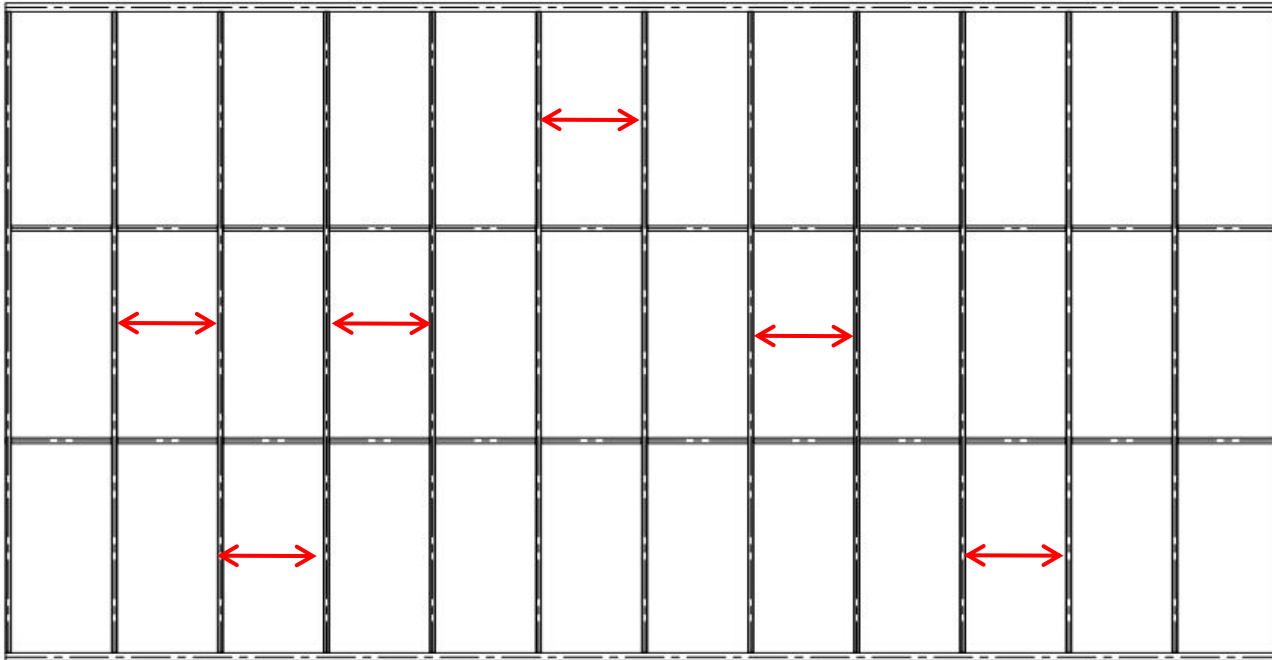

The distance between the vertical bars should be same as the width of cabinet. (The tolerance is 2mm)

4. Steel structure installation

Preparation before installation

-Measure Steel structure (Flatness)

Use wire to check the flatness of the front panel

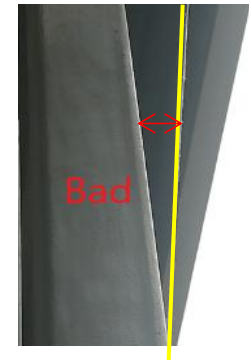
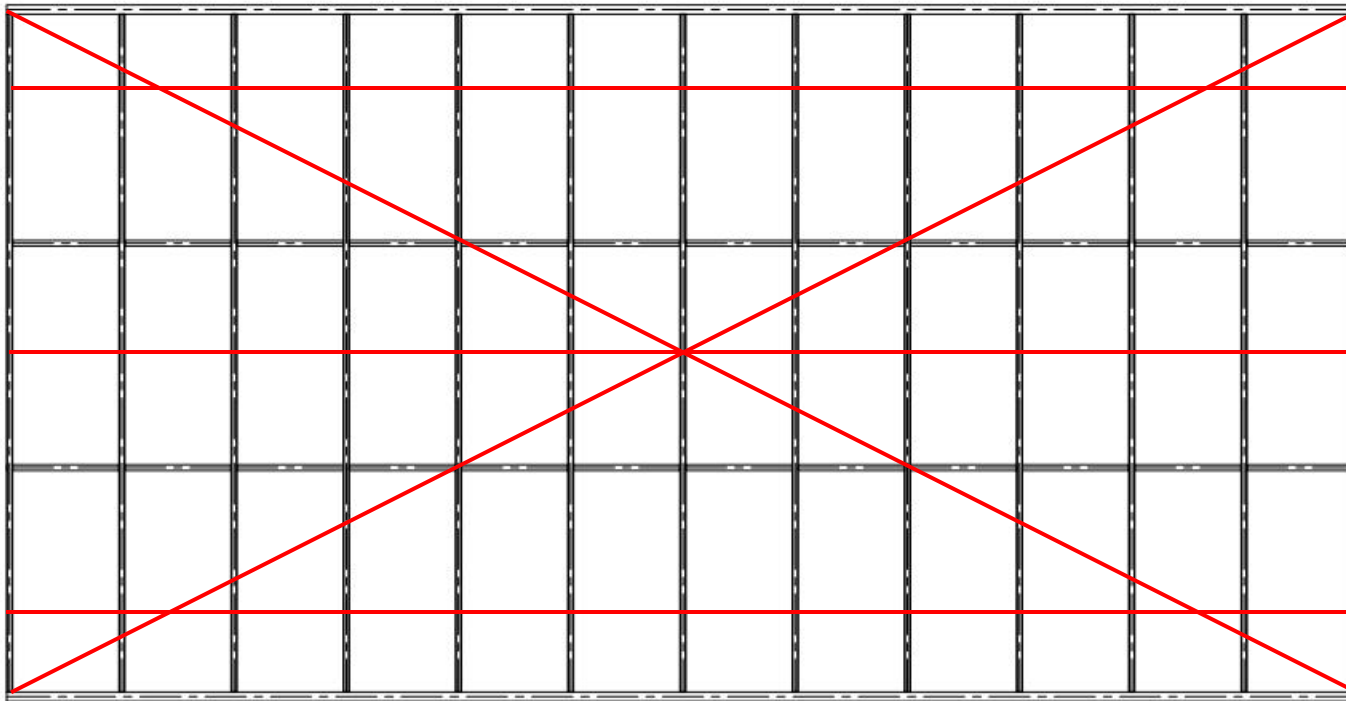

The distance between the measuring wire and the vertical bar should be less than 2 mm

5. Set installation

Cabinets installation

-Open package of cabinets

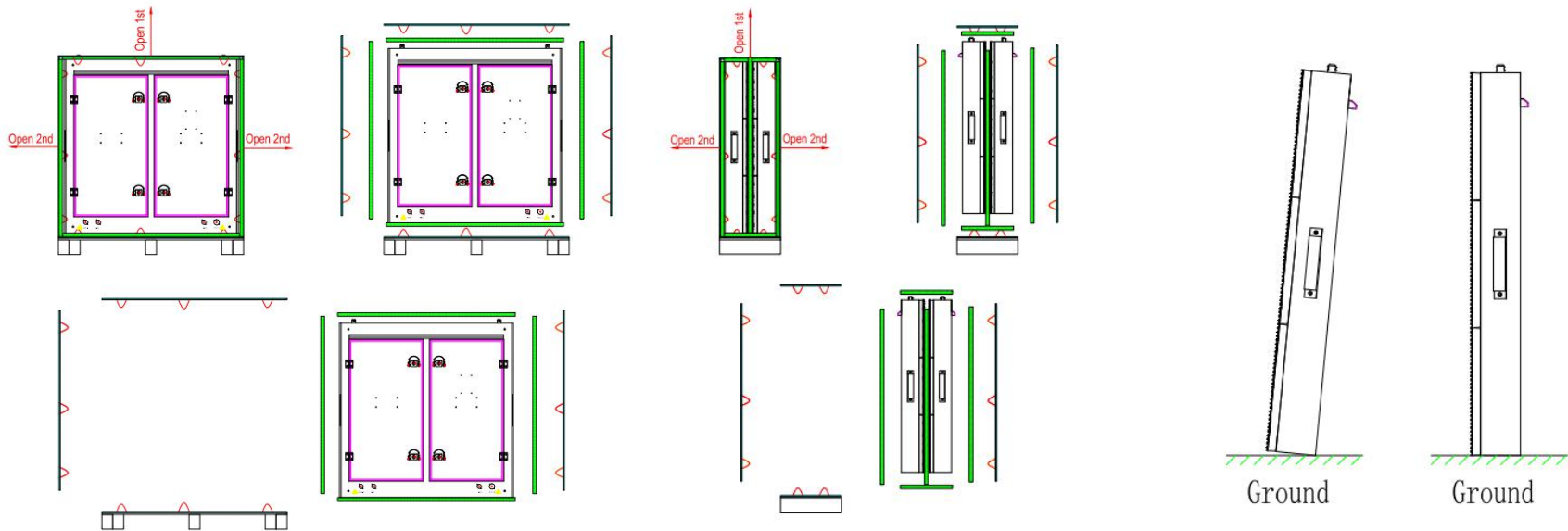

- Step 1: Open the top wooden cover
- Step 2: Open the side wooden cover
- Step 3: Take the cabinet out from the wooden box

After taking the cabinets out from the wooden box, when you place the cabinet on the ground, please put the back side on the ground first, then carefully put it standing on the ground as shown above to make sure the modules will not be damaged

5. Set installation

Cabinets installation -Installation process

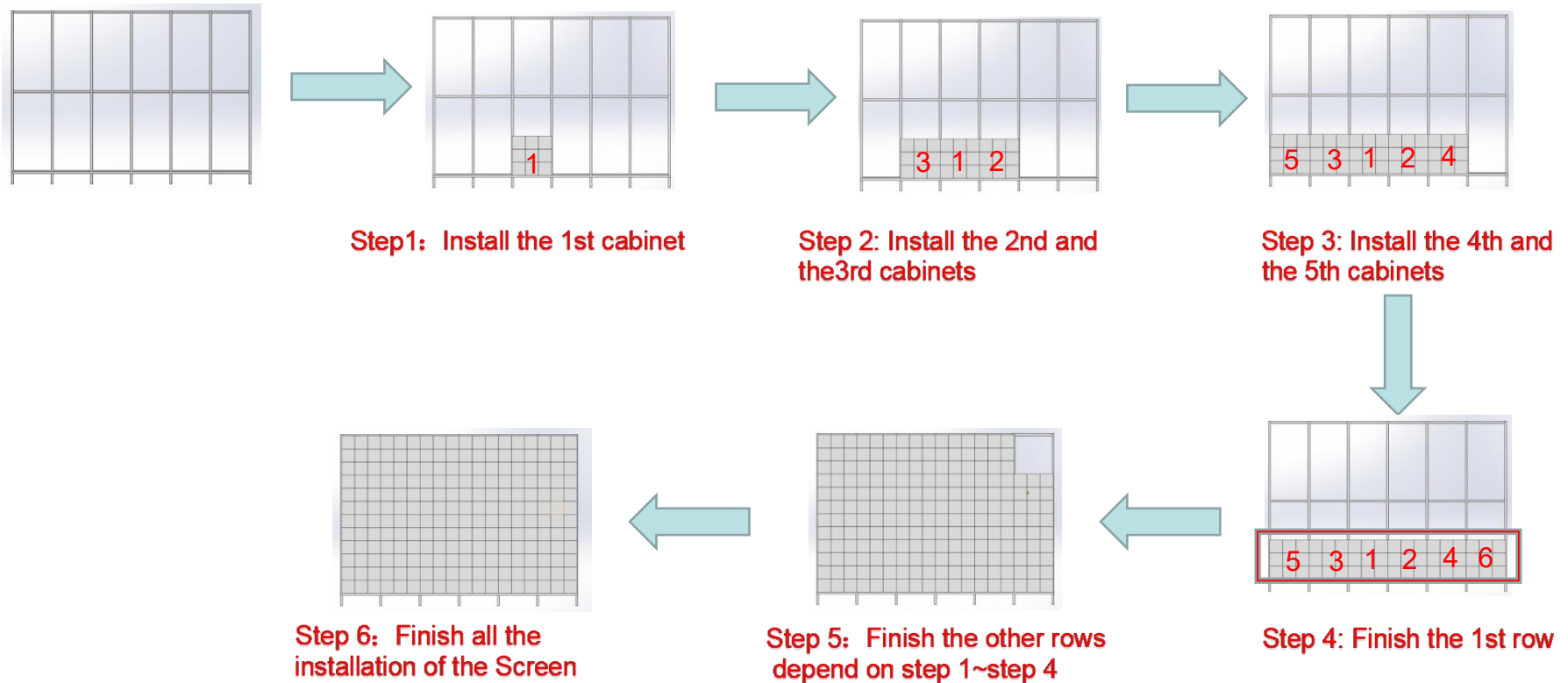

5. Set installation

Cabinets installation

- Gap mismatch management

Item	P6.67	P10	P16
Module to module	$\leq 0.4\text{mm}$	$\leq 0.4\text{mm}$	$\leq 0.4\text{mm}$
Module to structure	$\leq 0.8\text{mm}$	$\leq 0.8\text{mm}$	$\leq 0.8\text{mm}$
PCB waving	$\leq 1.5\text{mm}$	$\leq 1.5\text{mm}$	$\leq 1.5\text{mm}$
Cabinet to cabinet	$\leq 1\text{mm}$	$\leq 1\text{mm}$	$\leq 1\text{mm}$

5. Set installation

Cabinets installation

-Cabinet installation method (Rear installation)

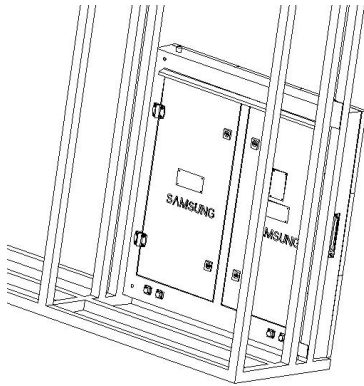

Step 1: Put the cabinet on the steel structure

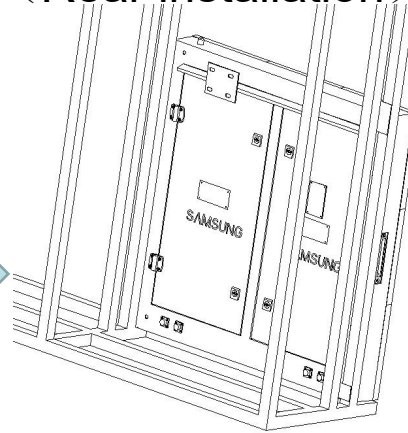

Step 2: Put the connection plate on the correct position

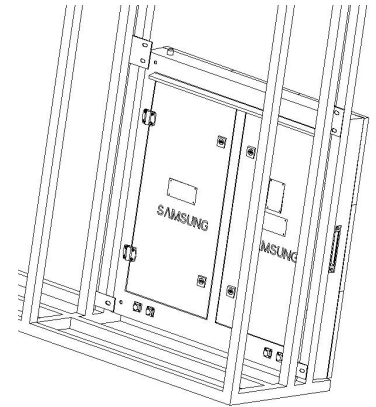

Step 3: Adjust the connection plate, make sure the hole position is correct

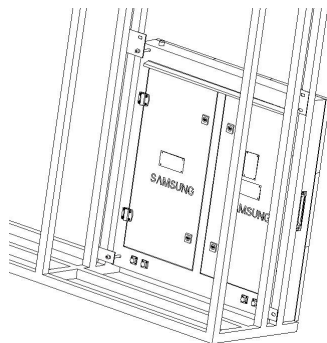

Step: Finish

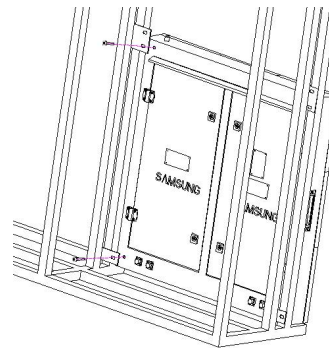

Step: Use M10 bolt to fix the cabinet

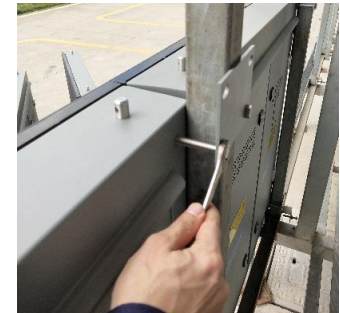

5. Set installation

Cabinets installation

-Cabinet installation method (Front installation)



Step 1: Remove the modules of the cabinet from front

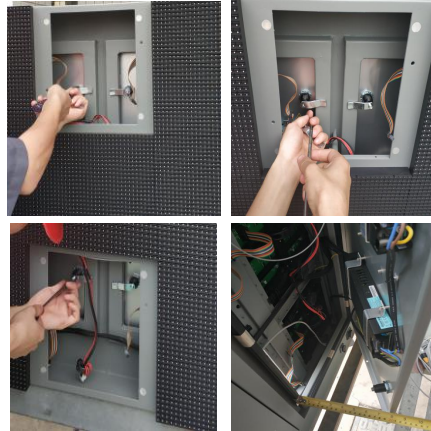

Step 2: open the door from front (25cm rear space for front service)

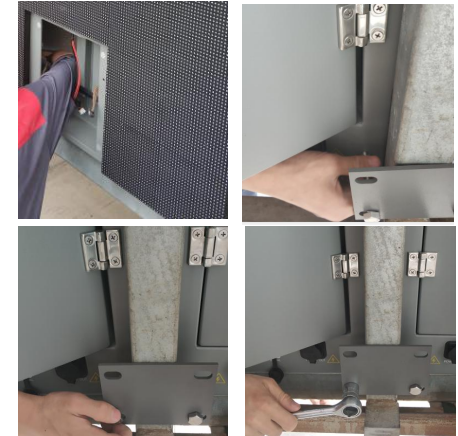

Step 3: install the connect plate and bolt from front

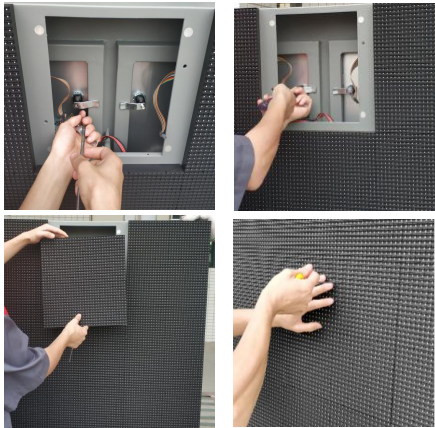

Step6: close the door tightly to prevent water leaks and install back the modules of the cabinet

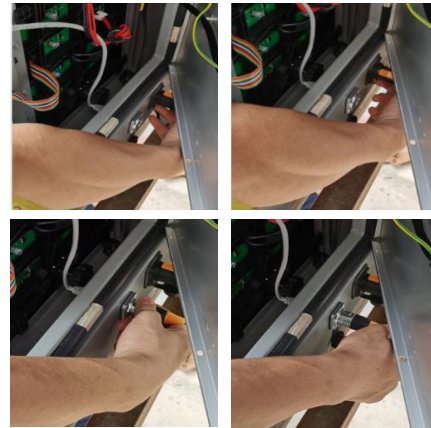

Step5: connect all the power cable and signal cable from front



Step4: finish the other connect plate and bolt from front of the cabinet

5. Set installation

Cabinets installation

-Module processing (Front installation)

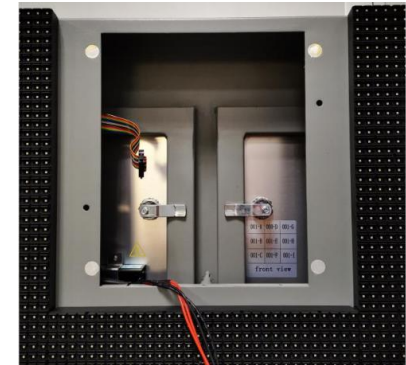
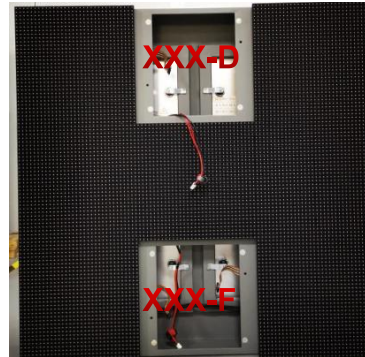
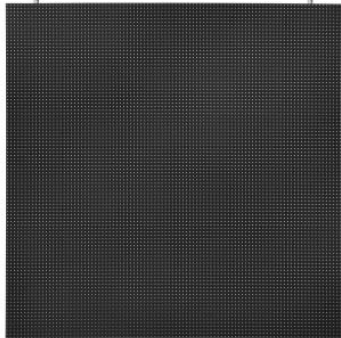

Step 1: Remove the two middle module
(Top row and bottom row)

Step 2: Check the lable for the cabinet
(The lable is on the door of the cabinet)

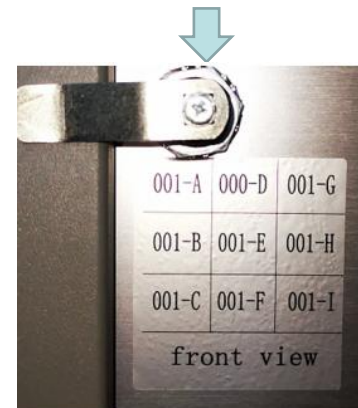
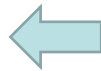
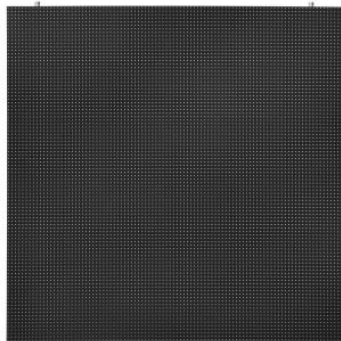

Step5: Finish module processing

Step5: Install back the same ID
module back the same ID cabinet on
the lable turn.

Step3: Check the module ID
and the cabinet ID

5. Set installation

Cabinets installation

-Maximum installation size

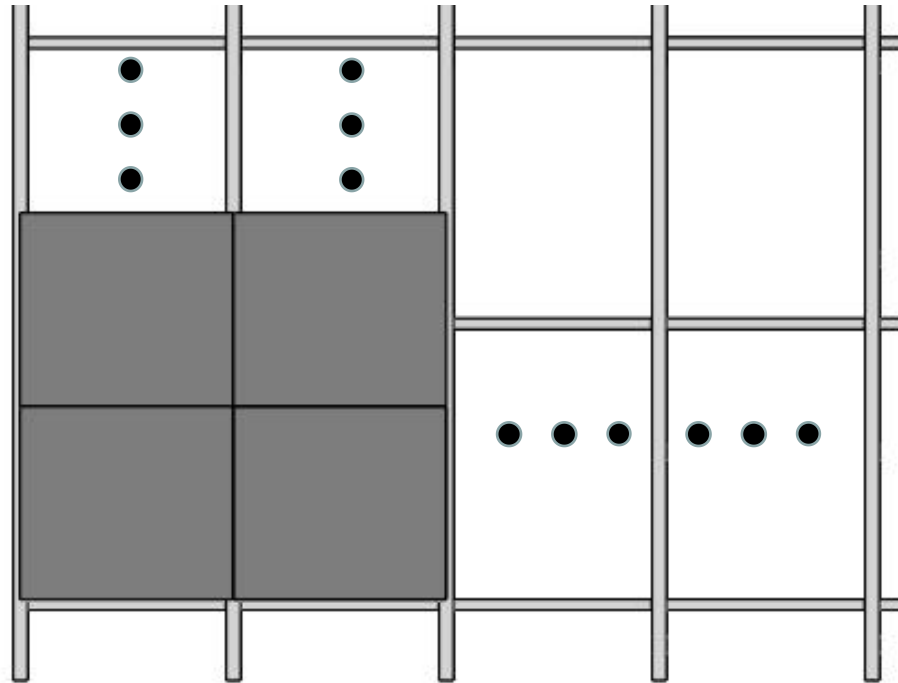



In theory, the LED display can be infinitely spliced as long as the steel structure and solder joints are sufficient to support the weight of the LED display.

5. Set installation

Cabinets installation

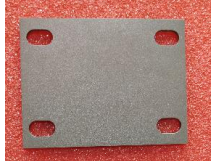
-Installation tools and accessories (Prepared by the factory)

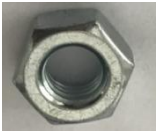
No.	Code	Name	Spec	Picture
1	R2J8-42-2403	Cabinet plate	130*50*4.0 (ROHS)	
2	R2J8-42-0200	Cabinet palte	130*100*4 (ROHS)	
3	R2W8-22-0466	M10*70 bolt		
4	R2W8-23-0120	Nut	GB/T6170 M10 A4-70	

6. Defference adjustments on set

Adjustment for installation

-Adjust gap between cabinet (Horizontally)

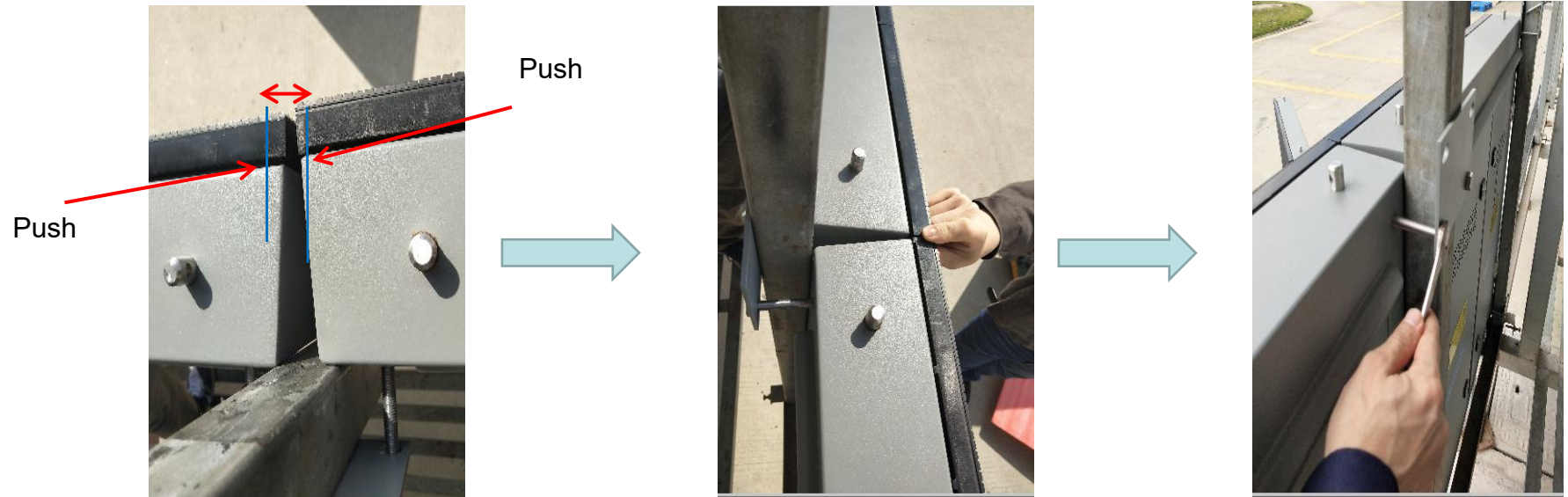

Push cabinet to fix the gap between cabinets

Check if the gap is disappeared

Use the spanner to fix the bolts

6. Defference adjustments on set

Adjustment for installation

-Adjust gap between cabinet (Vertically)

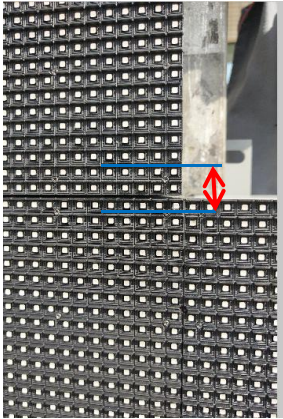

There is gap between cabinet (Vertical)



Use key onpen the back door of the cabinet



Use the Allen-key adjust the height of the bolts on the bottom of the cabinet



Check if the gap is disappeared



Use the spanner to fix the bolts

6. Defference adjustments on set

Adjustment for installation

-Adjust faltness of cabinets (Horizontally)

Push

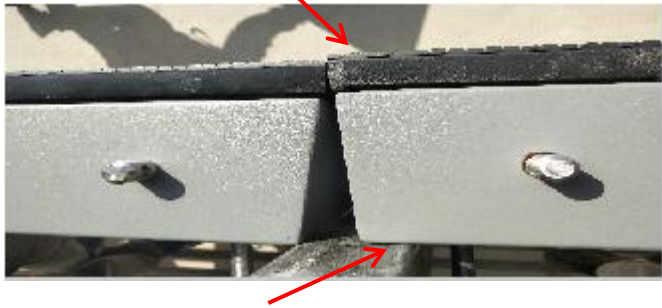

Push cabinet to fix the flatness difference between 2 cabinets

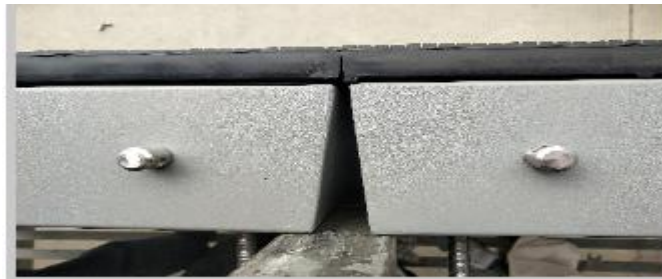

Check if the flatness difference is disappeared

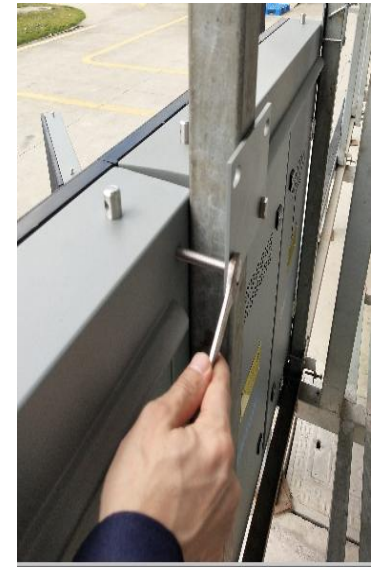

Use the spanner to fix the bolts

6. Defference adjustments on set

Adjustment for installation

-Adjust faltness of cabinets (Vertically)

Push



Push cabinet to fix the flatness difference between 2 cabinets

Check if the flatness difference is disappeared



Use the spanner to fix the bolts

7. Sending box connection

Connection to computer

-Connection drawing (sample) and cables

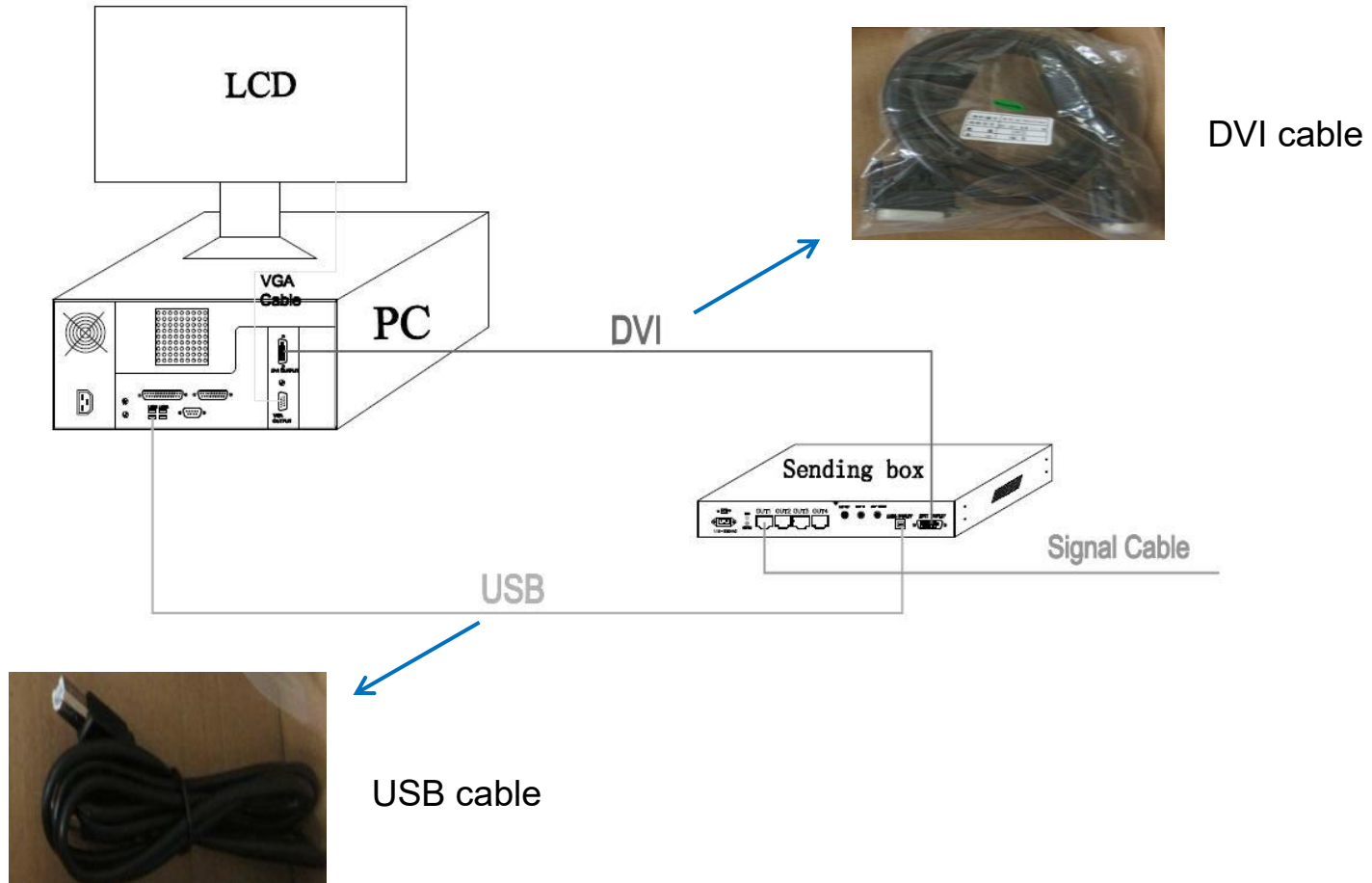

7. 1 DVI cable

Connection to computer

-connection between the computer and sending box



DVI-I cable
Length: 1.5M

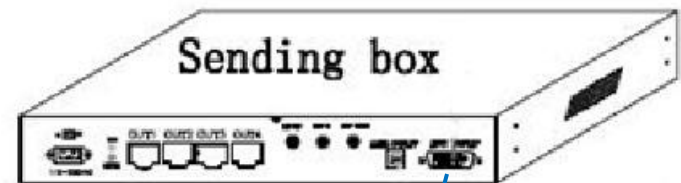

DVI-I interface

DVI-I is compatible with both DVI-D and DVI-A interfaces, which means that DVI-I can be compatible with both analog and digital signals.

8. Power and signal connection

Power connection

-Power connection drawing (sample) and cables



AC power input cable



AC power cascade cable

8. Power and signal connection

Power connection

-Power distribution box

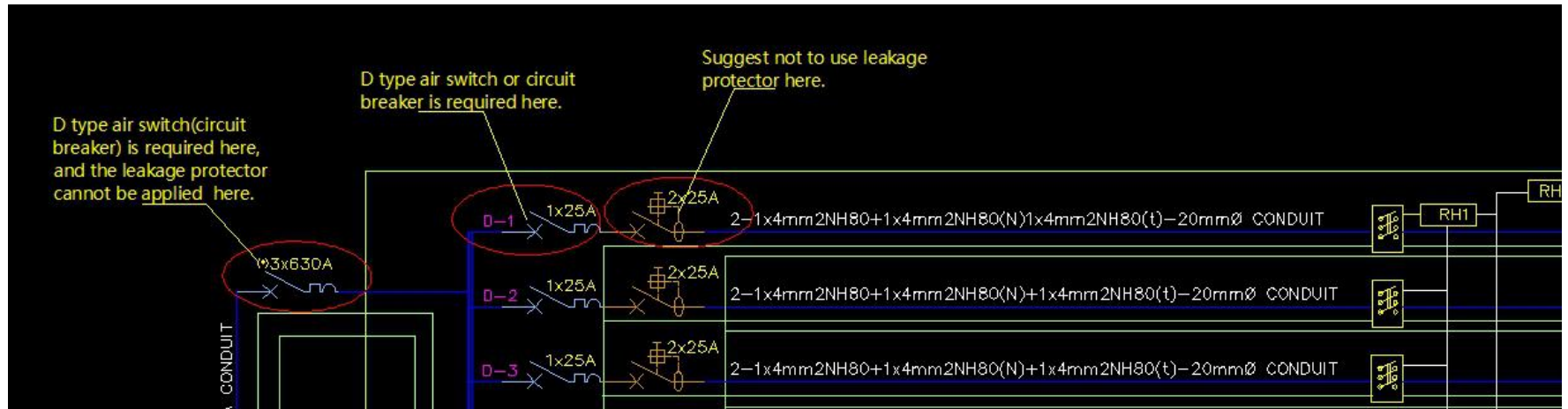

Since the LED screen product is an industrial-class product and has a relatively large power, it uses a high-power switch power supply. So, the start-up impact current at startup is relatively large. And then, the air switch which is used in the power distribution box needs to use a D-type switch. Prevent the screen from jumping when starting

8. Power and signal connection

Power connection

-Power distribution box (surge arrester)

Lighting Strike Protection of power distribution box

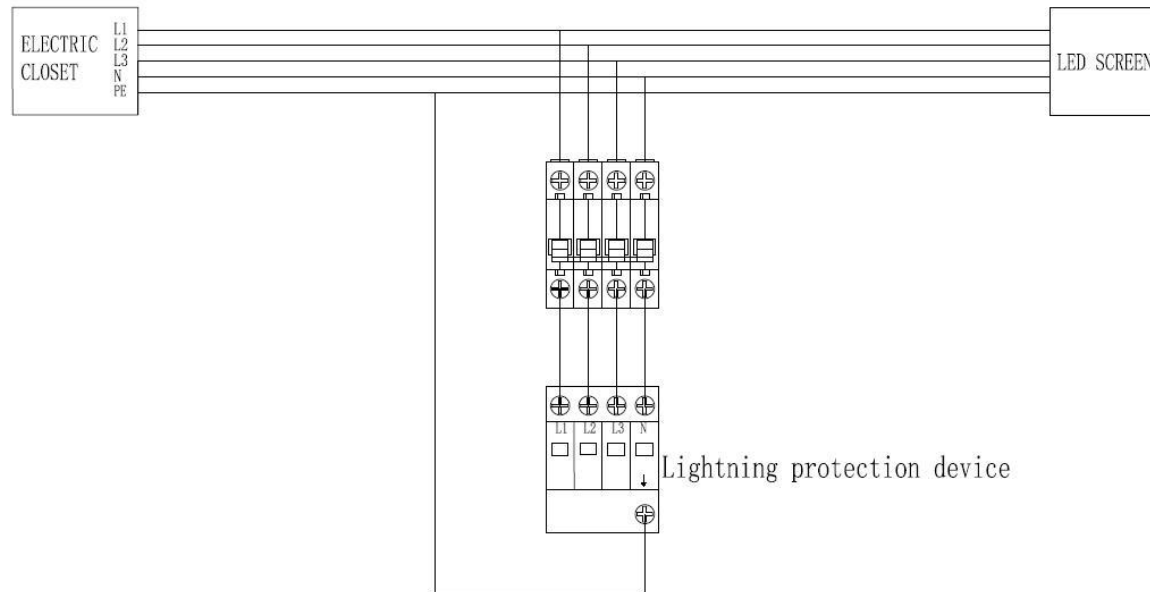

Every power distribution box of LED display screen must be installed with lightning protection device equipment. The requirement specification should be same as shown below. Nominal discharge current $I_n (8/20\mu s)$:20 kA

The maximum discharge current $I_{max} (8/20\mu s)$:40 kA

Voltage protection level:

Up in In AC385-505V: $\leq 1.7kV$

TA <25ns

8. Power and signal connection

Signal connection

-Signal connection drawing (sample) and cables



Signal cascade cable



Signal input cable

9. Module replacement

Module replacement (Rear service) -Deal with the bad display module

1. Power off the cabinet
2. Take off all the cables connected to module as shown below



3. open the lockes which fix the module on the cabinet structure as shown below.

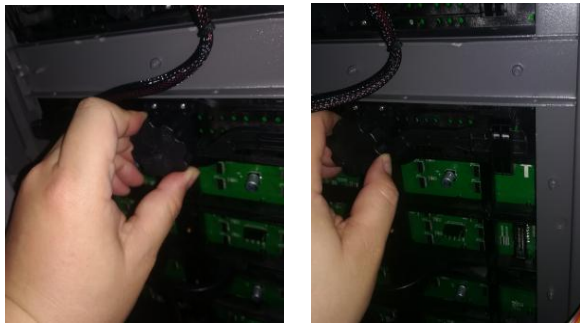

4. Remove the bad module and take it out from back side as shown below



Handle the back cover by hand

5. Put the new module on the cabinet structure and install all the lockes by hand. And then connect all the cables to the new one correctly

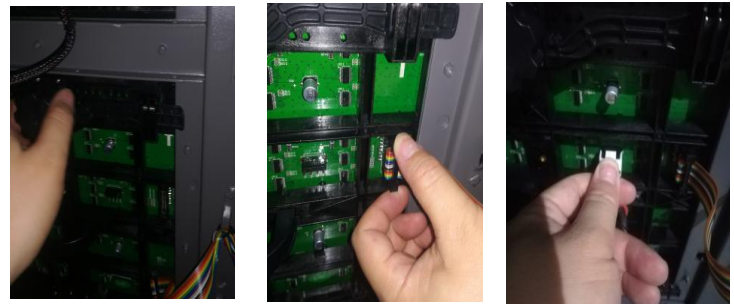

6. Turn on the cabinet

9. Module replacement

Module replacement (Front service)

-Deal with the bad display module

1. Power off the cabinet
2. Remove the module from front by front service tool as shown below



3. Remove the DC power cable and flat cable from the bad module, and then take off the bad module from cabinet by hand as shown below

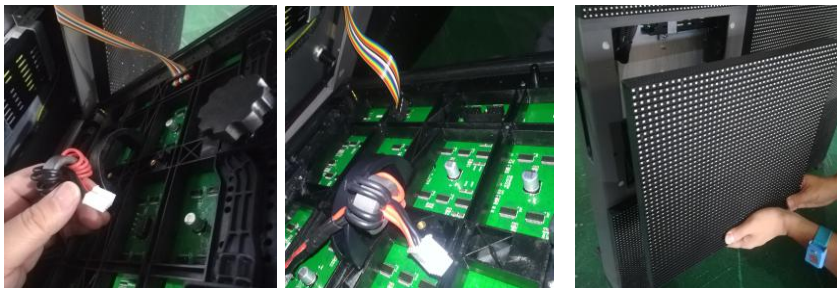

4. Bring a new module, connect the DC power cable and flat cable into the new module

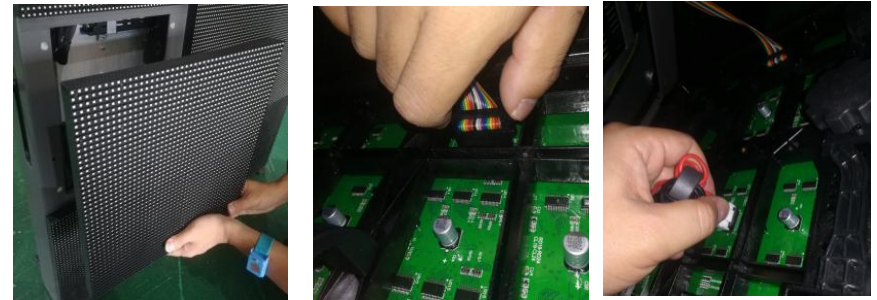

5. Put the new module on the cabinet and then install it into cabinet by front service tool as shown below



6. Power on the cabinet.

10. Software setting

Software setting (Control system) -Sending card setting

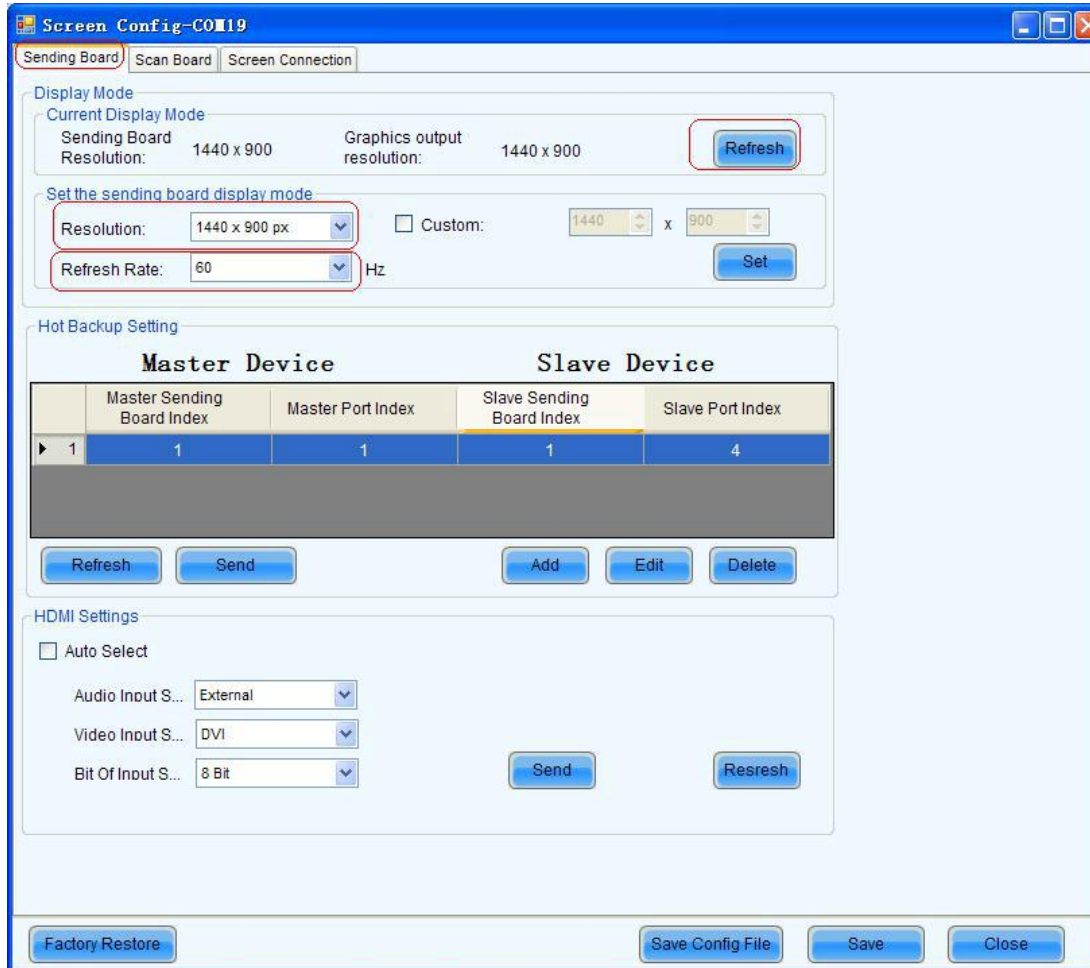

Enter `Screen Config`, choose `Sending Board` as shown left

Attention: Usually the resolution of transmitting card is bigger than the resolution of the LED display screen. For example, the resolution of the LED display screen is 1400*720, the user can not choose 1280*1024, must choose bigger than 1400*900.

Another notice: Every RJ-45 output of transmitting card can offer 650,000 pixels, if your LED display's pixels are more than this, you must use 2 cat-5 cable or more.

10. Software setting

Software setting (Control system) -Receiving card setting

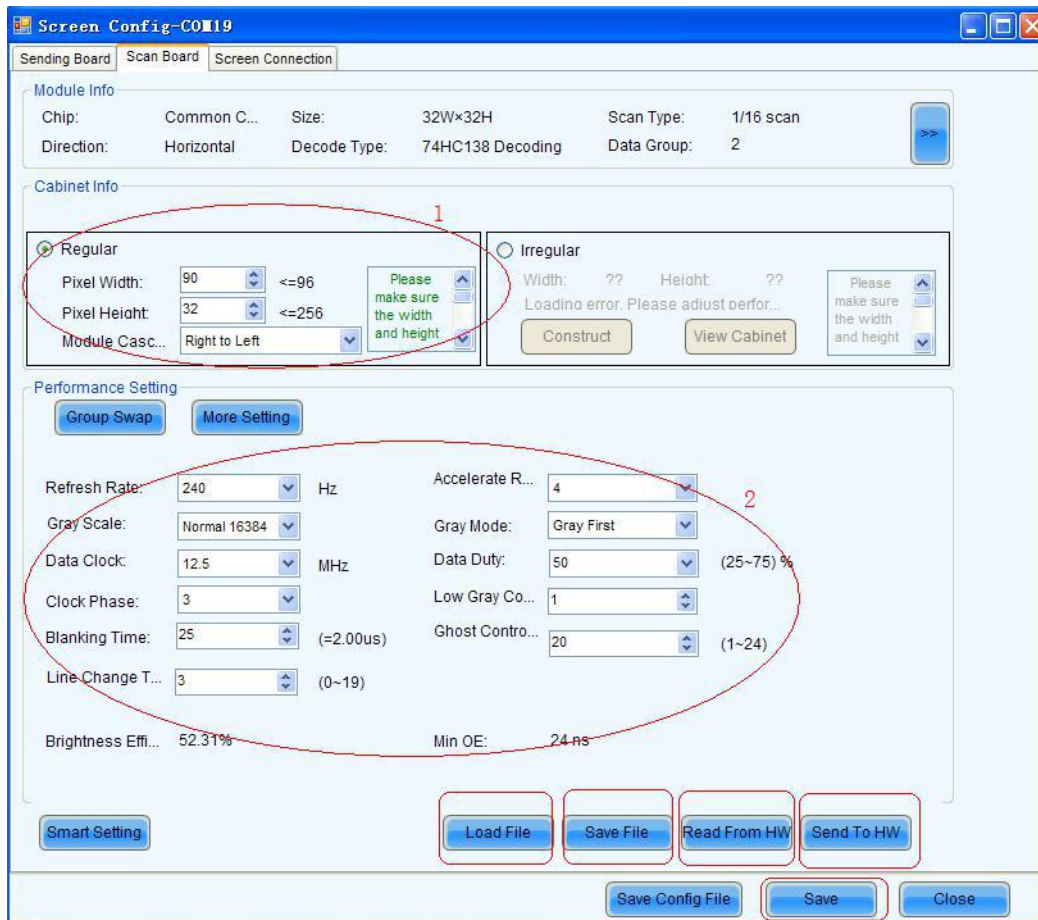

Choose the `Scan Board` as shown left

LoadFile: Load programmer file from PC, the file is saved and sent out by the manufacturer.

Save file: Save one new programmer file after adjusting parameter.

Read From HW: Read the programmer parameter which is saved into the scan boards in cabinets.

Send to HW: Send the programmer parameter which is loaded to all the scan boards in cabinets.

Save: Save the programmer parameter which is sent to all the scan boards in cabinets. After saving, you will not need to operate again.

Attention: We have loaded relative program to the receiving card before delivery and the file is also within the package of goods. It is unnecessary to follow this step, ONLY if you must operate it.

10. Software setting

Software setting (Control system) - Screen connection setting

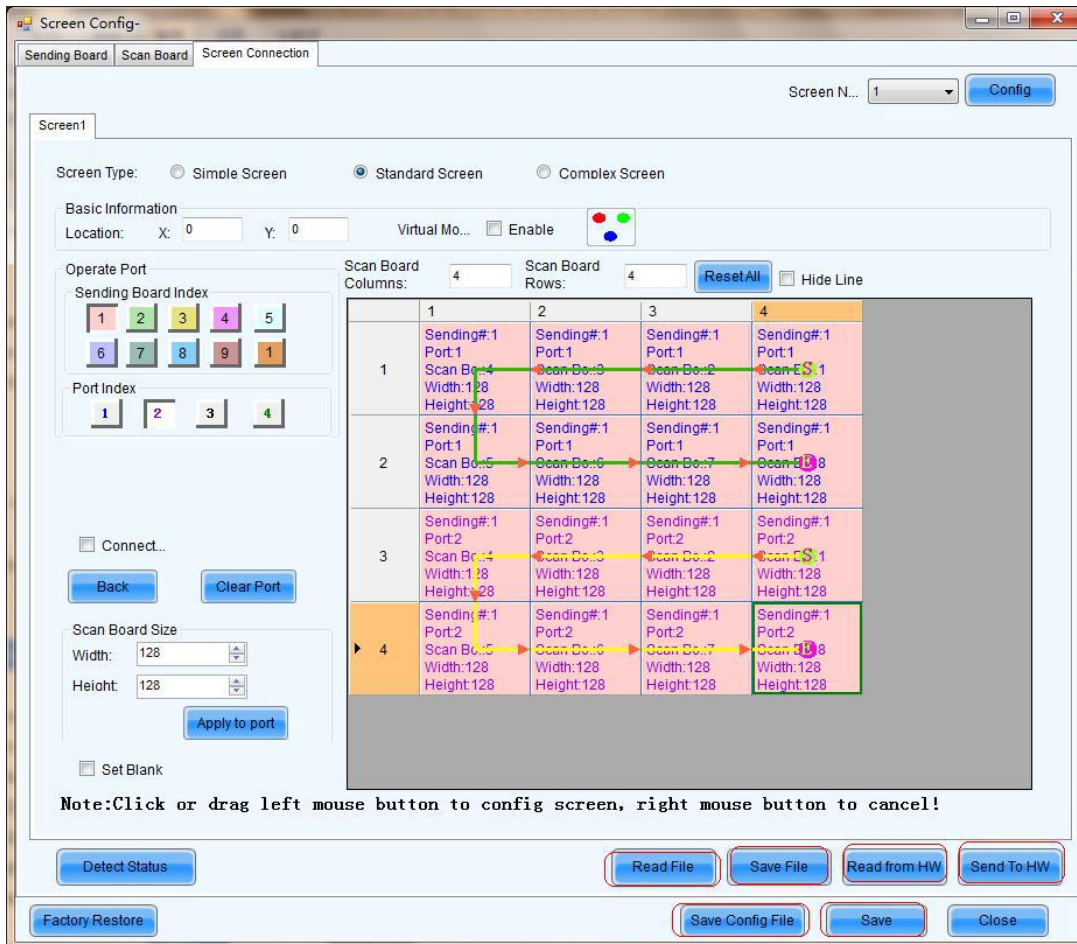

Choose the `Screen Connection` as shown left

Read File: Load connection table file from PC, the file is saved and sent out by the manufacturer.

Save File: Save one new connection table file after adjust parameter.

Read From HW: Read the connection table parameter which is saved to all the scan boards in cabinets.

Send To HW: Sent the connection table parameter which is loaded to all the scan boards in cabinets.

Save: Save the connection table parameter which is sent to all the scan boards in cabinets. After saving, you will not need to operate again.

Save Config File: Save all the configuration which is sent to all the scan boards in cabinets. After saving, you will not need to operate again.

Attention: Usually we will make the connection table file and send it to the user, but if you want use it, you must connect data cables according to data cable connection drawing which the manufacturer provides. Otherwise you should make a new one for your own connection. More operation details for Nova Control system should be check in software.

Appendix 1-Product accessories

The quantity of product accessories
-Depend on the project



Sending box

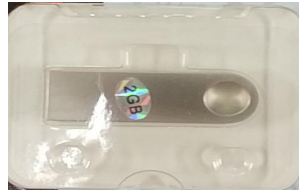

U Disk



DVI cable



USB cable



3 Cord power cable



AC power input cable



Signal input cable



AC power cascade cable



Signal cascade cable

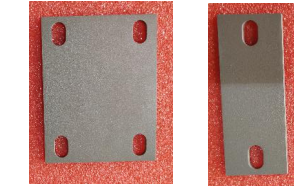

Connect plate



M10 Bolts



Key for back door

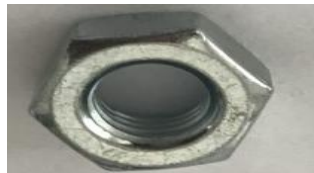

Nut



Tool for service (Front)



Service wire for door